



LUNA

BATHROOM COLLECTION



Caroma Classic is our most popular and affordable range of bathroom products. Loved by Australians for its proven reputation of high-quality construction, durability and longevity, these designs have become classics in homes across the country.

The Classic collection brings everyday luxury experiences through classic styles and functional design for people seeking DIY and good value bathroom products. So, you can create the sanctuary of your dreams, without compromise.

“With all your bathroom needs covered, the **Luna** collection delivers a consistent and modern look throughout.”



- Luke Di Michiel,
Caroma Industrial Designer



LUNA

The Luna collection offers timeless and enduring bathroom essentials that are well-designed with Australian ingenuity to suit your lifestyle.

The extensive product range features soft curves and sleek, modern designs which suit almost any bathroom and are practical for an everyday luxury bathroom experience.







Create your *sanctuary*



1
Luna Contemporary
Overhead Shower
System On Rail
90383C4E



3
Luna Above
Counter Basin
899000W



5
Luna Tower
Basin Mixer
68183C5A



6
Luna Bath/
Shower Mixer
68184C



2
Luna Wall Faced Invisi
Series II Toilet Suite
844910W



4
Luna Contemporary Single
Towel Rail 630mm
99612C



7
Luna Contemporary
Toilet Roll Holder
99607C



8
Luna Contemporary
Robe Hook
99608C



Create your *sanctuary*



①
Luna Contemporary
Back to Wall Bath
1400
LU4WFW

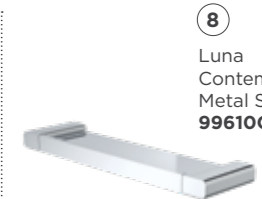

⑧
Luna
Contemporary
Metal Shelf
99610C



②
Luna
Contemporary
Multi Function
Hand Shower
90385C4F



④
Luna Inset
Vanity Basin
899215W



⑨
Luna Bath/
Shower Mixer
With Diverter
68185C



⑩
Luna Standard
Basin Mixer
68181C5A



⑤
Luna Contemporary
Double Towel Rail
630mm
99614C



⑪
Luna Wall Basin/
Bath Mixer
68186C5A



③
Luna
Cleanflush®
Wall Faced
Toilet Suite
844810W



⑥
Luna Contemporary
Straight Arm SQ
Flange 410MM
90389C



⑫
Luna
Contemporary
Toilet Roll Holder
99607C



Create your *sanctuary*

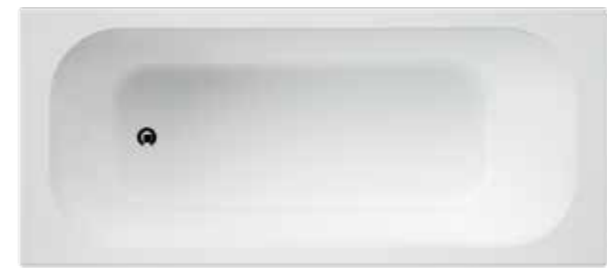

①
Luna Four Tile
Flange Bath 1675
LU7W



⑦
Luna Close
Coupled S Trap
Back Entry
Toilet Suite
844810W

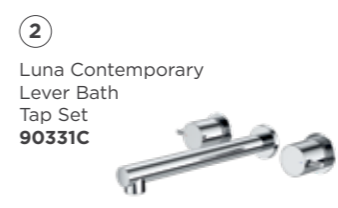

②
Luna Contemporary
Lever Bath
Tap Set
90331C

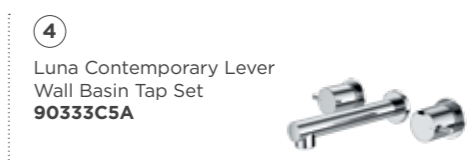

④
Luna Contemporary Lever
Wall Basin Tap Set
90333C5A



③
Luna
Contemporary
Multi Function
Rail Shower
90384C3A



⑤
Luna Semi
Recessed Basin
(Without Tap
Landing)
873500W

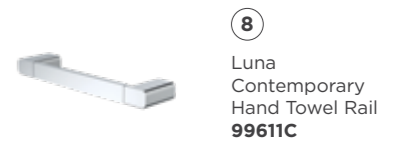

⑧
Luna
Contemporary
Hand Towel Rail
99611C

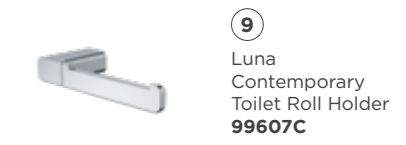

⑨
Luna
Contemporary
Toilet Roll Holder
99607C



⑥
Luna Contemporary Single Towel Rail 630mm
99612C

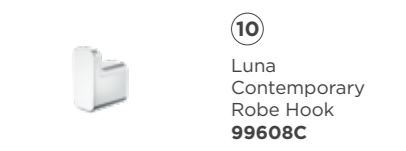

⑩
Luna
Contemporary
Robe Hook
99608C

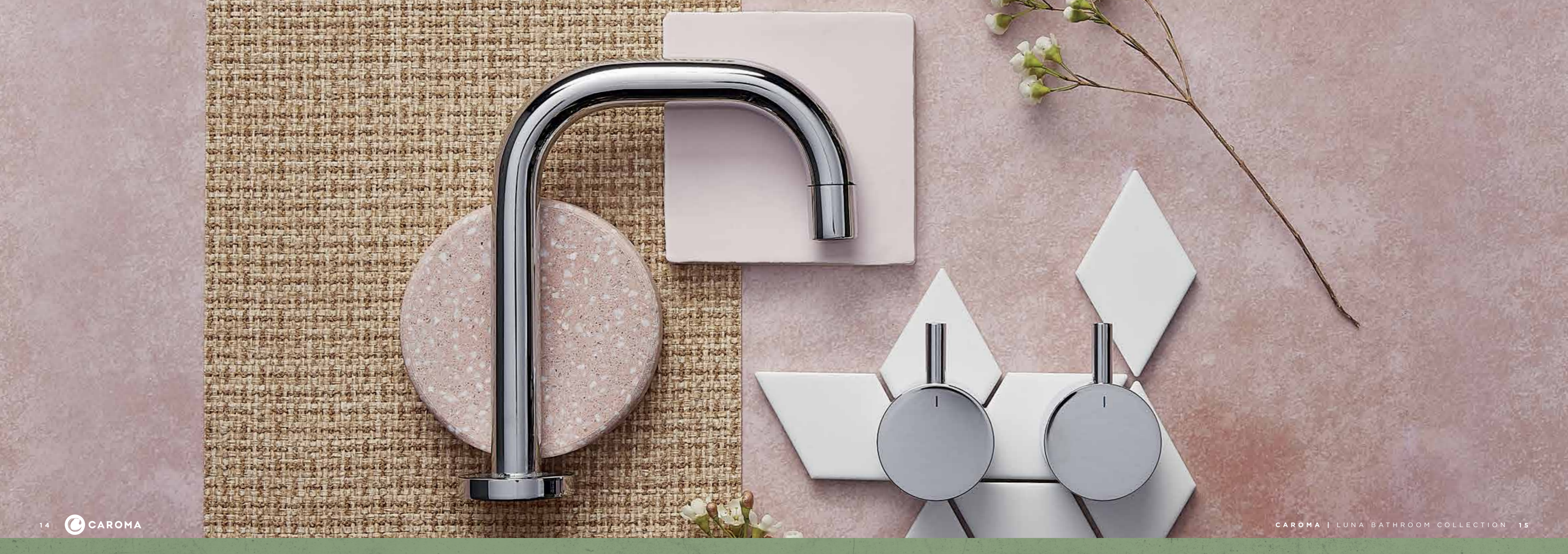



Basins

Luna basins are curved and classic in their design, making them a stylish choice for your bathroom that will stand the test of time.

With many style and size options available, you'll be spoilt for choice when selecting basins for a small ensuite through to a large family bathroom.

- Crafted from highly durable vitreous china that has great durability, sanitary and stain resistant properties
- Available in above counter, semi recessed, inset and wall basin styles
- Includes flush fitting plug and waste - optional pop up plug and waste available
- 10 year warranty

ABOVE COUNTER BASIN

Above counter basins are installed directly on top of a vanity with minimal installation requirements.

INSET BASIN

Inset basins are partially set into a vanity reducing the appearance of the basin rim without reducing the depth of the bowl.

SEMI RECESSED BASIN

Semi recessed basins partially overhang the vanity allowing you to maximise your basin size on applications with limited vanity space.

WALL BASIN

Wall basins are installed directly to the wall with no need for an additional vanity.



Luna Inset Vanity Basin

0 tap hole 899205W
1 tap hole 899215W
3 tap hole 899235W



Luna Inset Vanity Basin (Without Tap Landing)

0 tap hole 899105W



Luna Above Counter Basin

0 tap hole 899000W



Luna Semi Recessed Basin

0 tap hole 873605W
1 tap hole 873615W



Luna Semi Recessed Basin (Without Tap Landing)

0 tap hole 873500W



Luna Shelf Wall Basin

0 tap hole 873905W
1 tap hole 873915W
3 tap hole 873935W

Right hand shelf and left hand shelf available



Luna Wall Basin

0 tap hole 874205W
1 tap hole 874215W
3 tap hole 874235W



Luna Hand Wall Basin

1 tap hole 873715W



Luna Waste

687329C



Caroma wall basins are tested to withstand excess load up to 150kg **5x industry standard**

EN 14688 : 2015 Sanitary appliances - wash basins - functional requirements and test methods.

Showers

A sleek, modern shower will not only enhance the appearance of any bathroom but also your daily bathing experience.

Our Luna range of eco-friendly showers are engineered with a superior water saving rating, without any compromise on performance.

- Long lasting chrome finish
- Includes silicone nozzles and premium Silverflex shower hose for durability and easy cleaning
- WELS 4 star rated
- 10 year warranty

FIXED SHOWER

A fixed arm with a pivoting head either from the wall or ceiling for a clean stylish look.

HAND SHOWER

Provides added functionality to a fixed wall option with the ability to remove the handpiece.

SHOWERS ON RAILS

Convenient, adjustable height rail for ultimate control.



FIXED SHOWER

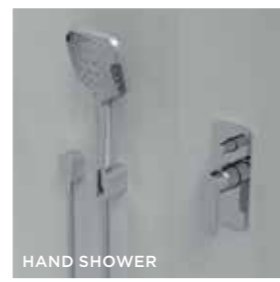

HAND SHOWER



SHOWERS ON RAILS

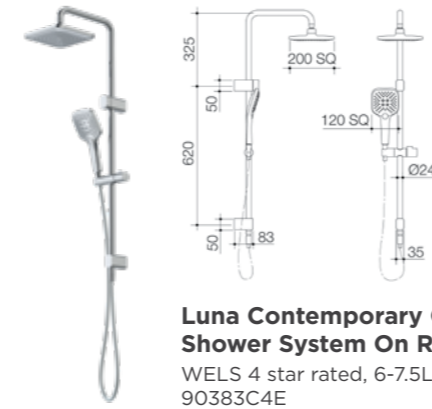

Luna Contemporary Overhead Shower System On Rail
WELS 4 star rated, 6-7.5L/min
90383C4E

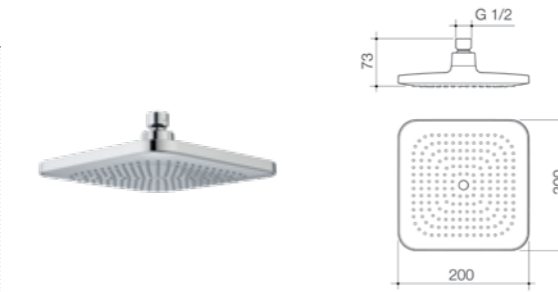

Luna Contemporary Overhead Shower Head Only
WELS 4 star rated, 6-7.5L/min
90386C4E

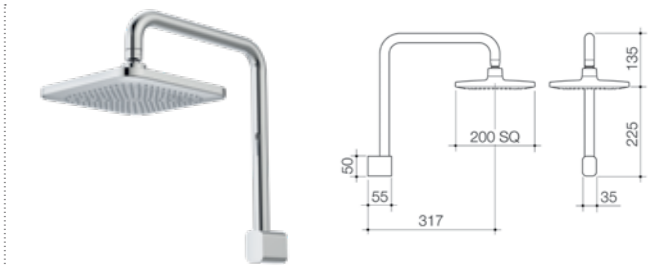

Luna Contemporary Fixed Overhead Shower
WELS 4 star rated, 6-7.5L/min
90391C4E



Luna Contemporary Multi Function Rail Shower
WELS 4 star rated, 4.5-6L/min
90384C4F



Luna Contemporary Ceiling Shower Arm 210mm
90388C

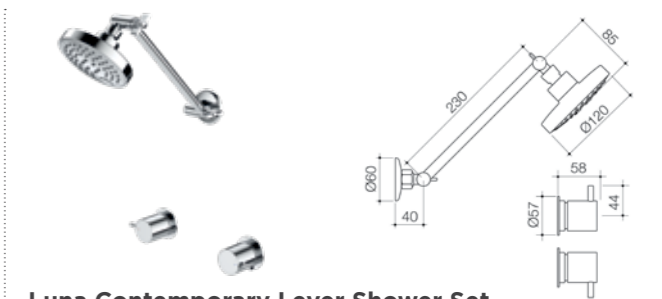

Luna Contemporary Lever Shower Set
WELS 3 star rated, 7.5-9L/min
90332C3A



Luna Contemporary Multi Function Hand Shower
WELS 4 star rated, 4.5-6L/min
90385C4F



Luna Contemporary Ceiling Shower Arm 410mm
90389C

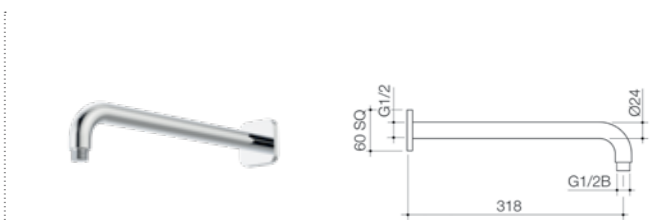

Luna Contemporary Ceiling Shower Arm
Right angle
90390C

Baths

Our range of Luna baths feature soft lines for a modern, minimalistic look. The gentle recline allows you to lie back and relax in style.

- Crafted from stain and scratch resistant sanitary grade acrylic
- Available in freestanding, back to wall, island and four tile flange styles
- Includes flush fitting plug and waste – optional pop up plug and waste
- 10 year warranty

FREESTANDING BATH

The Luna freestanding bath is only 1400mm in length, meaning that even small bathrooms can have this luxurious style of bath.

BACK TO WALL FREESTANDING BATH

The Luna back to wall bath combines the luxury of a freestanding bath with the practicalities of an island bath. Sitting flush to the wall means it is not only easy to clean but opens up the choice of tapware to wall bath mixers.

ISLAND BATHS

Island baths are recessed into a constructed frame which is usually finished using tiles or stone leaving only the small raised rim of the bath visible. The island bath offers extra room around the bath, perfect for candles, a sitting ledge, or the kids' toys.

FOUR TILE FLANGE BATHS

This style is necessary for a bath that will also be used as a shower. It works to redirect the shower spray run-off directly back into the bath without the moisture damaging the walls.



FREESTANDING BATH



ISLAND BATH

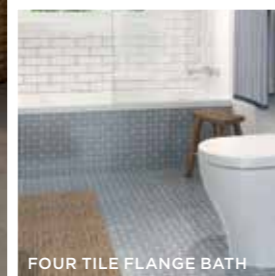

FOUR TILE FLANGE BATH



Luna Contemporary Freestanding Bath

1400

LU4FSW

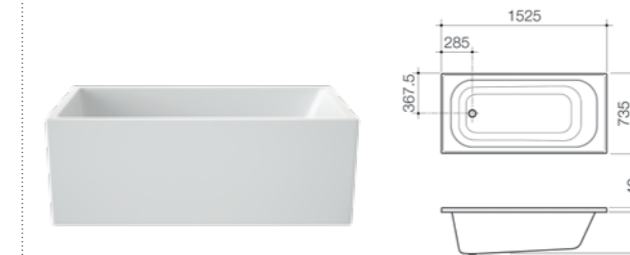

Luna Four Tile Flange Bath

1525

LU5W

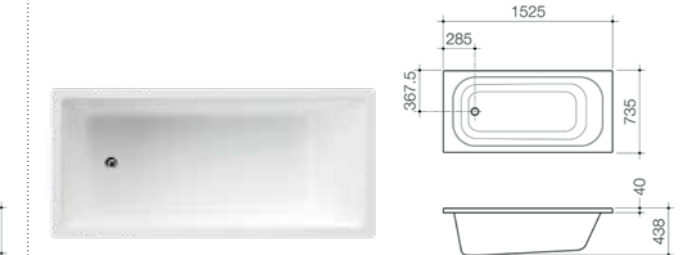

Luna Island Bath

1525

LU5ISW



Luna Contemporary Back to Wall Bath

1400

LU4WFW

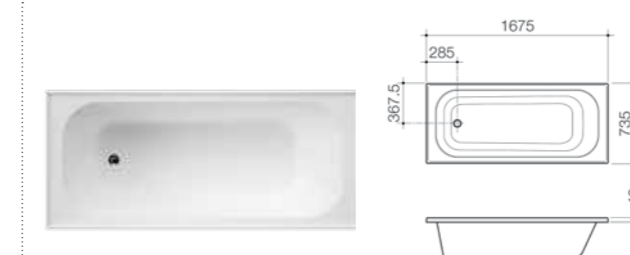

Luna Four Tile Flange Bath

1675

LU7W

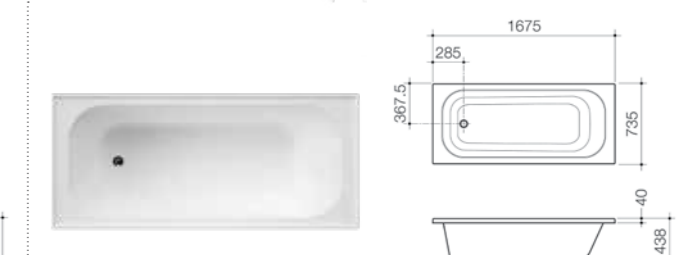

Luna Island Bath

1675

LU7ISW

Tapware

Updating your tapware is a quick and easy way to modernise your bathroom. The Luna tapware range has been designed to be retrofitted to existing bathrooms or be the perfect stylish addition to any new bathroom. The curved shape makes for easy cleaning and care.

- Hard-wearing solid brass construction with durable chrome finish
- Includes ceramic disc cartridge to eliminate drips and minimise maintenance
- WELS 4 or 5 star rated
- 10 year warranty

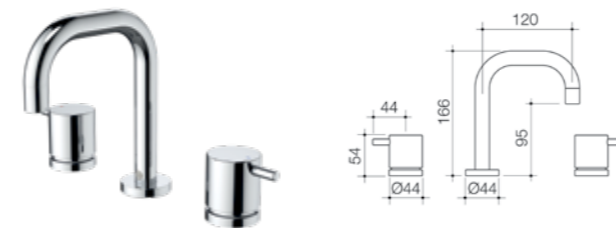

Luna Contemporary Lever Basin Tap Set
WELS 5 star rated, 4.5-6L/min
90334C5A



Luna Contemporary Lever Basin Handle Set
Basin mount
90335C



Luna Contemporary Lever Washing Machine Tap Set
WELS 4 star rated, 7.5L/min
90336C

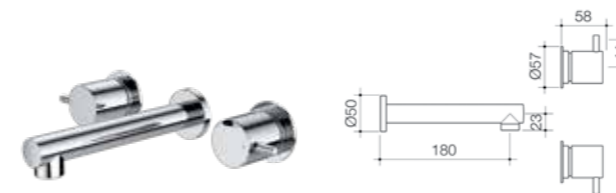

Luna Contemporary Lever Wall Basin Tap Set
WELS 5 star rated, 4.5-6L/min
90333C5A

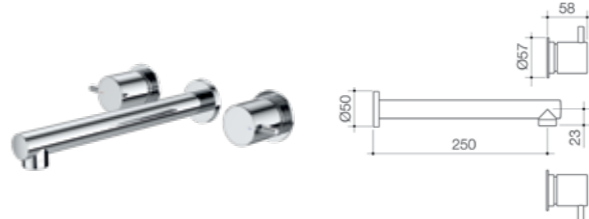

Luna Contemporary Lever Bath Tap Set
90331C

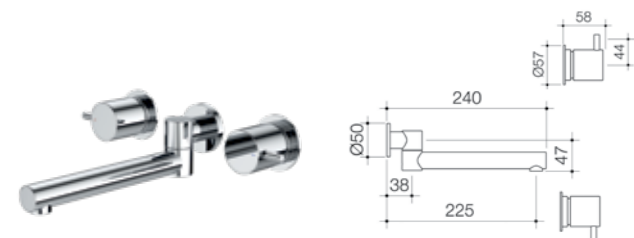

Luna Contemporary Lever Laundry Tap Set
WELS 4 star rated, 6-7.5L/min
90331C4A



Luna Contemporary Lever Basin Outlet 185mm
WELS 5 star rated, 4.5-6L/min
90335C5A

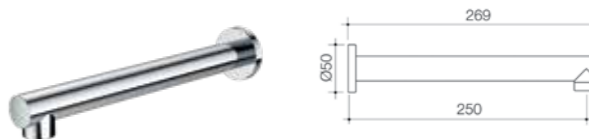

Luna Contemporary Lever Bath Outlet 250mm
90337C



Luna Contemporary Lever Wall Handle Set
Wall mount
90332C



Mixers

The subtle curves of the Luna mixer range bring a modern but timeless feel to your bathroom.

- Hard-wearing solid brass construction with durable chrome finish
- Available in 3 different heights to suit your basin type
- Ultraflex PEX hoses provide superior durability and cleanliness while easy clean silicone aerator prevents limescale build up
- WELS 4 or 5 star rated
- 10 year warranty

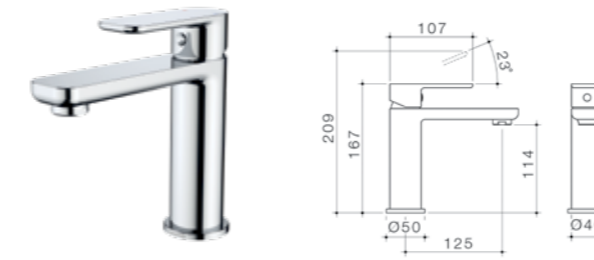

Luna Standard Basin Mixer
WELS 5 star rated, 6L/min
68181C5A

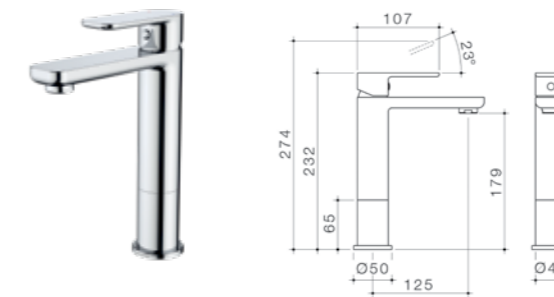

Luna Mid Basin Mixer
WELS 5 star rated, 6L/min
68182C5A

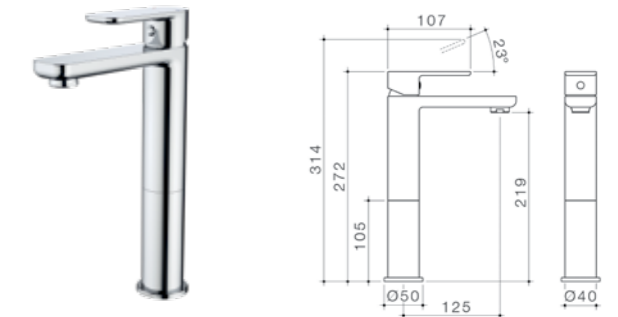

Luna Tower Basin Mixer
WELS 5 star rated, 6L/min
68183C5A

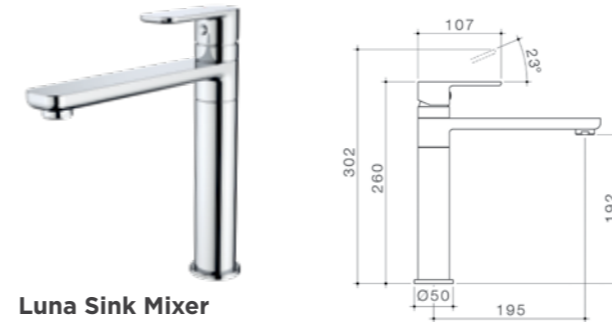

Luna Sink Mixer
WELS 4 star rated, 7.5L/min
68188C4A

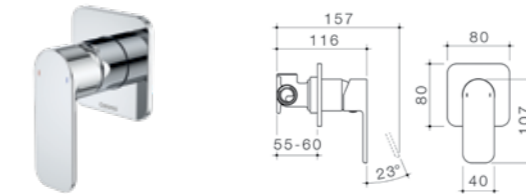

Luna Bath/Shower Mixer
Without Diverter
68184C

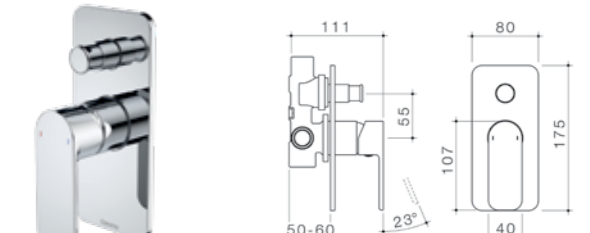

Luna Bath/Shower Mixer With Diverter
With Diverter
68185C



Luna Wall Basin/Bath Mixer
WELS 5 star rated, 6L/min
68186C5A



Luna Wall Basin/Bath Outlet
WELS 5 star rated, 6L/min
68187C5A

Toilet suites

Our Luna range of toilet suites feature Caroma patented Cleanflush® technology. Caroma Cleanflush® is our most effective and hygienic toilet. Our patented design features revolutionary rimless technology that delivers the next generation of toilets: easy to clean and water efficient with superior hygiene.

- Designed in Australia
- Available in wall faced or close coupled: wall faced options include Caroma's patented Uni-Orbital® connector for ease of installation
- Back entry or bottom inlet cistern: universal trap for S or P installations
- WELS 4 star rated
- 10 year warranty

INVISI WALL FACED TOILET SUITES (BEHIND THE WALL / CONCEALED)

The toilet pan sits on the floor and is connected to a cistern concealed inside the wall cavity, ceiling or under counter.

WALL FACED TOILET SUITE (OR BACK TO WALL)

The toilet pan sits flush to the wall with the cistern mounted directly on top.

CLOSE COUPLE TOILET SUITE

The toilet pan sits on the floor with the cistern mounted directly on top, leaving a small gap between the pan and the wall.



FLOW SPLITTER
Powerful flush for whole bowl clean



FLOW CHANNELS
Controlled water flow eliminates splash back



FLOW BALANCER
Precise flush stream effectively clears the bowl

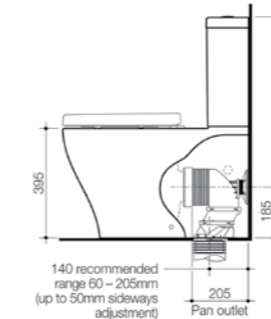

Luna Cleanflush® Wall Faced Toilet Suite

WELS 4 star rated, 4.5/3L (3.5L avg/flush)

Bottom Inlet* 844810W
Back Entry* 844820W

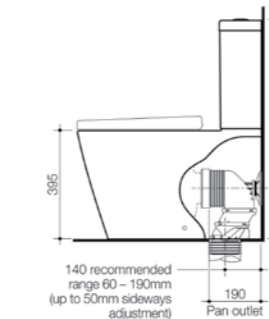

Luna Square Cleanflush® Wall Faced Toilet Suite

WELS 4 star rated, 4.5/3L (3.5L avg/flush)

Bottom Inlet* 846410W
Back Entry* 846420W

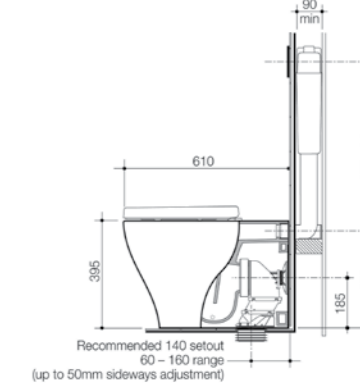

Luna Cleanflush® Wall Faced Invisi Series II® Toilet Suite

WELS 4 star rated, 4.5/3L (3.5L avg/flush)

Back Entry* 844910W

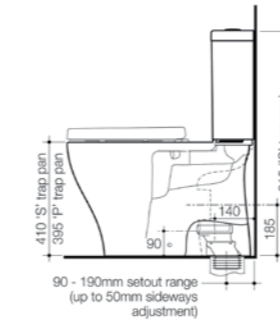

Luna Cleanflush® Close Coupled P Trap Toilet Suite

WELS 4 star rated, 4.5/3L (3.5L avg/flush)

P Trap Bottom Inlet* 844720W
P Trap Back Entry* 829740W

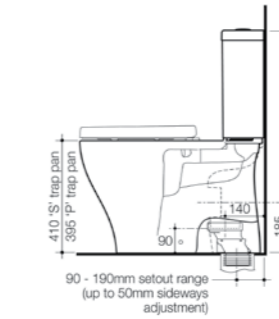

Luna Cleanflush® Close Coupled S Trap Toilet Suite

WELS 4 star rated, 4.5/3L (3.5L avg/flush)

S Trap Bottom Inlet* 844710W
S Trap Back Entry* 829730W

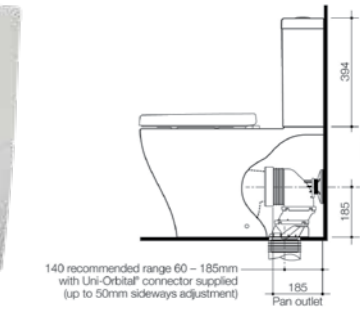

Luna Wall Faced Toilet Suite

WELS 4 star rated, 4.5/3L (3.5L avg/flush)

Bottom Inlet* 829710W
Back Entry* 829720W

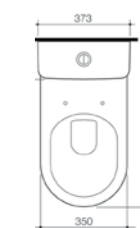

*Bottom Inlet - for installation flexibility
*Back Entry - for a concealed connection



Accessories

Our Luna range of accessories bring the finishing touch to your bathroom. The range of towel rails, hooks, shelves and toilet roll holders will complement the rest of your choices from the Luna collection.

- Durable metal construction with long lasting chrome finish
- Dual fixings for added strength
- 1 year warranty

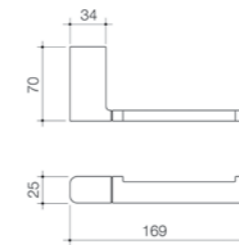

Luna Contemporary Toilet Roll Holder
99607C

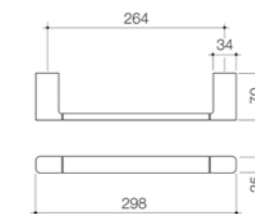

Luna Contemporary Hand Towel Rail
99611C

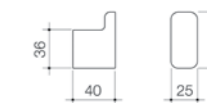

Luna Contemporary Robe Hook
99608C

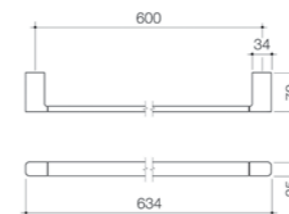

Luna Contemporary Single Towel Rail 630mm
99612C

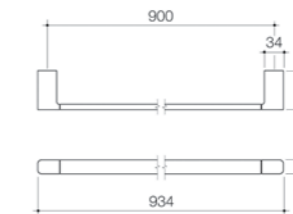

Luna Contemporary Single Towel Rail 930mm
99613C



Luna Contemporary Metal Shelf
99610C

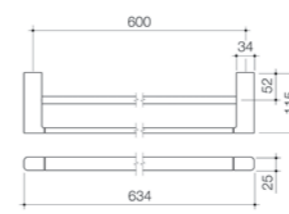

Luna Contemporary Double Towel Rail 630mm
99614C

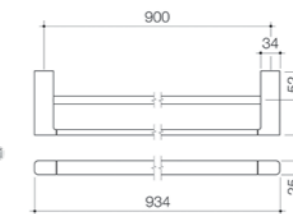

Luna Contemporary Double Towel Rail 930mm
99615C





With over 75 years of experience, we believe quality bathrooms are a balance of form, function and looks. Our designs and innovation bring to life a guiding vision of creating sustainable luxury. Design that enables you to enjoy bathroom experiences that both complement and elevate your lifestyle, from an energising morning start to an indulgent, relaxing moment of luxury, all underpinned by sustainability.

Designing for Australians and New Zealanders, from all walks of life, with different tastes and needs; we have a wide range of classic to artisanal styles, smart designs and sustainable innovations providing you with everything you need to create the *sanctuary of your dreams.*

www.caroma.com.au | www.caroma.co.nz

© Copyright 2019. Caroma Industries Ltd. ABN 35 000 189 499. All rights reserved. Material and design specifications subject to change without notice. Product colour reproduction is as near to actual product colour as production methods allow. Warning: Products in this brochure are the subject of registered designs and patents. ® is a registered trademark of Caroma Industries. This brochure relates to Australian products only and some product, design or specifications may differ in other countries.