



Contents

- 03** The forefront of innovation begins here
- 04** Caroma LiveWell sub-brand story
- 06** Case study: Mark Moran Vacluse
- 08** Solution driven collection
- 10** Independent living solutions
- 12** Aged care solutions
- 14** Accessible solutions
- 16** Toilet suites
- 20** Nurse call button
- 22** Basins
- 26** Medical basins
- 28** Tapware
- 32** Dementia friendly tapware
- 34** Medical tapware
- 36** Support rails and shower seat
- 38** Grab rails and showers



The forefront of innovation begins here

Caroma has partnered with The University of New South Wales (UNSW) Built Environment to better understand the needs, desires and expectations of Australians towards bathrooms to support them as they age.

Insights and information gained from our research is used by our Research and Design team to support innovative product development for those who require more assistance with access and mobility.

By better understanding user preferences and task performance of older people and people with disabilities, Caroma has been able to develop superior independent living products, improving the confidence and mobility of our consumers in the bathroom space.

We are proud to be at the forefront of trusted wellbeing solutions, to help us support our consumers in aging and living gracefully.



UNSW
SYDNEY



Our Caroma LiveWell Collection specialises in providing beautiful designs which enhance the wellbeing of Australians and New Zealanders who need a little extra assistance in the bathroom. We understand that bathroom design is an important factor in promoting independency in the home for longer and our industrial designers have worked closely with health and aged-care experts to create this comprehensive range of products, designed to deliver innovative solutions that surpass industry standards.

Designed with practicality at the core, our trusted LiveWell Collection enables comfortable living at every stage of life. LiveWell includes a versatile range of styles that enables you to create a unique space that both complements and elevates your lifestyle.

“We designed the **LiveWell** Collection with practicality and dignity in mind. The fusion of contemporary styles with discreet modifications promote comfort and independence for those with greater needs.”



P Sweatman

- Dr Peter Sweatman,
Caroma Design Researcher



Case study: Mark Moran Vaucluse

We provide solutions for hundreds of aged care projects each year.



The Mark Moran complex in the exclusive Sydney suburb of Vaucluse is a luxury retirement, aged care and wellness precinct, more reminiscent of a high-end boutique hotel than a traditional aged care facility. Featuring a state-of-the-art gymnasium, restaurant, quality room service, luxury spa, cinema and a unique digital concierge service, the facility is the perfect combination of serenity and class, while maintaining a welcoming and homely feel. Along with independent living units, Mark Moran Vaucluse comprises a range of aged care and rehabilitation units, with each one purposefully designed to ensure residents can enjoy life with maximum independence.

An important aspect of the design for Mark Moran Vaucluse was the specification of kitchen and bathroom fittings and fixtures. So, architects Marchese Partners turned to Caroma for expert advice.

We offer a range of kitchen and bathroom fittings specifically designed to assist seniors and those less mobile to live independently, including products compliant with AS1428.1 2009 Amd.1 design for access and mobility requirements.

With toilet access sometimes difficult for those with limited mobility, Marchese Partners specified the Caroma Opal II Wall Faced Easy Height Toilet. This modern, streamlined toilet has a raised seat height, which makes it easier for those with restricted movement to transfer

onto and off the toilet. The architects also specified the Caroma Care 800 Wall Faced Close Coupled Toilet with Backrest. As well as a raised seat height, this toilet has a built-in backrest which provides support to those with limited core stability when sitting or performing tasks that require leaning back. The backrest, as well as the raised pan height and increased pan projection mean that this toilet is compliant with AS1428.1 standard.

Limited hand strength and mobility can often make using standard tapware challenging. For Mark Moran Vaucluse, Marchese Partners specified the Caroma G Series+ Concealed Wall Sink Lever Taps. These taps have large lever-style handles and feature ceramic disc cartridges for smooth, easy activation and greater water control, making them ideal for aged care facilities. Marchese Partners also specified the streamlined Opal 510 Wall Basin and the Cube Extension Wall Basin, which can both be installed to comply with the AS1428.1 standard.

Products specified include:

- Caroma Opal II Wall Faced Easy Height Toilet Suite
- Caroma Care 800 Wall Faced Close Coupled Toilet with Backrest
- G Series+ Concealed Wall Sink Lever Taps
- Opal 510 Wall Basin
- Cube Extension Wall Basin

Solution driven collection

Our Caroma LiveWell Collection includes a versatile range of solutions to create a unique and practical bathroom space, whether in aged care facilities or for AS1428.1-2009 compliant bathroom fitouts.



INDEPENDENT LIVING SOLUTIONS

LiveWell have an excellent range of options to help with the everyday routines for people needing more safety and support. The Opal range was designed for that trusted luxury experience, delivering all the benefits of assistive technology integrated throughout the bathroom.



AGED CARE SOLUTIONS

Designed to assist people with restricted mobility, these products not only look great but are ideal for Aged Care applications.



ACCESSIBLE SOLUTIONS

Products for accessible applications need to deliver optimum access and mobility to comply with Australian standards. Our range of accessible products meet the requirements as outlined in AS1428.1 2009 Amd.1 design for access and mobility requirements.

This image is representative of Accessible products. Please refer to AS1428.1-2009 for further information.

Create your *sanctuary*

INDEPENDENT LIVING SOLUTIONS

LiveWell have an excellent range of options to help with the everyday routines for people needing more safety and support. The Opal collection was designed for that trusted luxury experience, delivering all the benefits of assistive technology integrated throughout the bathroom.



① Opal Cleanflush® Easy Height Wall Faced Close Coupled Suite with Double Flap Seat **985300W**

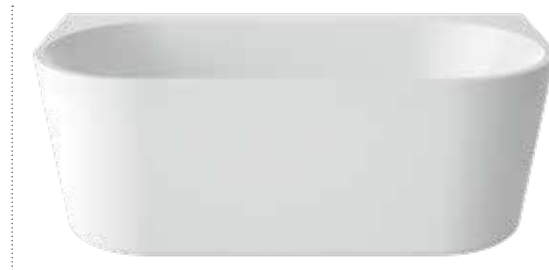

⑥ Aura 1800 Back to Wall Bath **AU8WFW**

⑭ Opal Support Rail 90 Degree Left or Right Hand Angled **687380C**

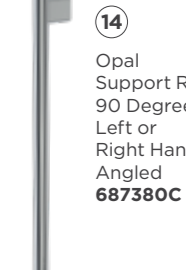

② Opal Support Rail 135 Degree Right Hand Angled **687379C**



⑦ Opal Support Rail 600mm Straight **687377C**



⑪ Liano Nexus Wall Basin/Bath Mixer Platemount Kit **96164C**



③ Opal Support Corner Shower Rail **687383W**



⑧ Liano Swivel Bath Outlet **880001C**



⑫ Opal 720 Wall Basin with Left Hand Shelf (with optional Shroud) **632200W**

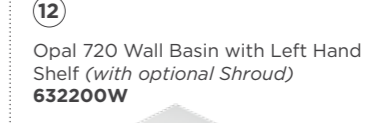

④ Opal Support Corner Shower Rail with Basket **687384W**



⑨ Liano Nexus Bath/ Shower Mixer **96130C**

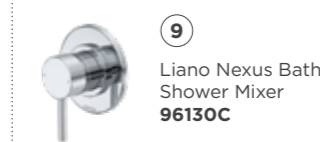

⑤ Opal Support Folding Shower Seat **687385W**

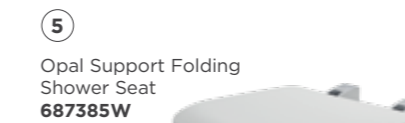

⑩ Liano Basin Outlet 180mm **96154C5A**



⑬ Opal Shroud (for Opal basins) **632601W**

⑮ Opal Support 90 Degree Left or Right Hand Angled Shower Rail with Slider* **687381C**
*Shower rail only





Create your *sanctuary*

AGED CARE SOLUTIONS

Designed to assist people with restricted mobility, these products not only look great but are ideal for Aged Care applications.



①
Care 660 Cleanflush®
Easy Height Wall
Faced Suite with
Grey Seat
846912AG



③
Caravelle Classic
Lever Basin Set
631243C5A



④
Care Shroud
873170W



②
Care Wall Basin 700 with Left Hand Shelf
(with optional Shroud)
873430W



⑤
Virtu Comfort
Grab Rail 300mm
84730040



⑥
Virtu Comfort Grab Rail 1000mm
84710040



⑦
Virtu Plus Starsafe II
Shower (900mm Rail)
782732A



⑧
Caravelle Classic
Lever Wall Top Set
631245C



Create your *sanctuary*

ACCESSIBLE SOLUTIONS

Products for accessible applications need to deliver optimum access and mobility to comply with Australian standards. Our range of accessible products meet the requirements as outlined in AS1428.1 2009 Amd.1 design for access and mobility requirements.



① Care 800 Cleanflush® Wall Faced Invisi Series II Suite with Backrest and Caravelle Care Single Flap Seat 718320BW



③ Care 700 Wall Basin with Left Hand Shelf 873410W



④ Skandic Care Basin Mixer 90995C5A



② Virtu Comfort Shower Seat 84796040



⑤ Virtu Comfort Grab Rail 140 Degree Left Hand Angled 8478475440



⑥ Virtu Plus Starsafe II Inverted T Accessible Shower Set Right Handed 782741A

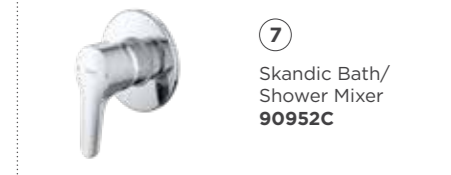

⑦ Skandic Bath/Shower Mixer 90952C

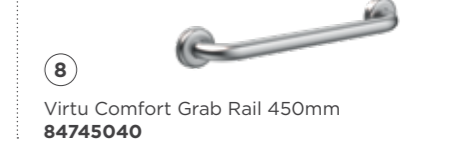

⑧ Virtu Comfort Grab Rail 450mm 84745040

This image is representative of Accessible products. Please refer to AS1428.1-2009 for further information.

Caroma Cleanflush® is our most effective and hygienic toilet. Our patented design features *revolutionary rimless technology* that delivers the next generation of toilets: easy to clean and water efficient with *superior* hygiene.



FLOW SPLITTER
Powerful flush for whole bowl clean



FLOW CHANNELS
Controlled water flow eliminates splash back



FLOW BALANCER
Precise flush stream effectively clears the bowl

Toilet suites

The patented and streamlined rimless design of the modern Opal Cleanflush® collection brings style and functionality to the bathroom. Added benefits such as Cleanflush® for maximum hygiene and optional nurse call armrests are designed to improve independence and wellbeing for users and carers. The Opal Cleanflush® suite is an ideal option for your home, retirement living and residential aged care facilities.

- Designed and engineered in Australia
- Features award-winning Caroma Cleanflush® technology - hygienic design for easy cleaning
- Easy height pan makes it easier on the knees reducing the wear and tear over time
- Long projection on the Pan allows easier access for carers and also commode chair use
- Supplied with patented Uni-Orbital® connector for flexible S or P trap installations - extends to any position up to a 50mm radius
- WELS 4 star rated
- 10 year commercial and domestic warranty

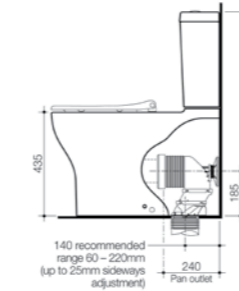

Opal Cleanflush® Easy Height Wall Faced Suite

WELS 4 star rated, 4.5/3 (3.5L average flush)

- | | | |
|-----------------------------|----------|---|
| Single flap white | 985400W | ○ |
| Double flap white | 985300W | ○ |
| Double flap anthracite grey | 985700AG | ● |
| Double flap black | 985600BL | ● |

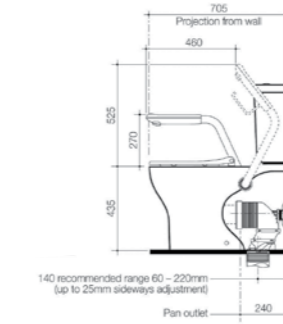

Opal Cleanflush® Easy Height Wall Faced Suite with Armrests

WELS 4 star rated, 4.5/3 (3.5L average flush)

- | | | |
|-----------------------------|------------|---|
| Single flap white | 985400ARW | ○ |
| Double flap white | 985300ARW | ○ |
| Double flap anthracite grey | 985700ARAG | ● |
| Double flap black | 985600ARBL | ● |

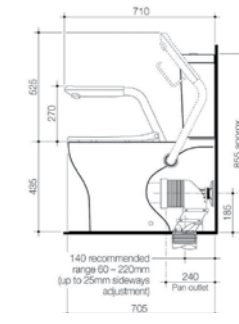

Opal Cleanflush® Easy Height Wall Faced Suite with Nurse Call Armrests

WELS 4 star rated, 4.5/3 (3.5L average flush)

- | | | |
|--------------------------------|---------------|---|
| Left nurse call button | | |
| Single flap white | 985400ARWNCL | ○ |
| Double flap white | 985300ARWNCL | ○ |
| Double flap anthracite grey | 985700ARAGNCL | ● |
| Double flap black | 985600ARBLNCL | ● |
| Right nurse call button | | |
| Single flap white | 985400ARWNCR | ○ |
| Double flap white | 985300ARWNCR | ○ |
| Double flap anthracite grey | 985700ARAGNCR | ● |
| Double flap black | 985600ARBLNCR | ● |

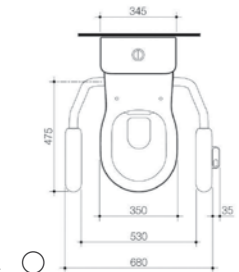

Toilet suites

Our Caroma Care toilet suites all feature our award-winning Cleanflush® technology, an innovation that delivers a more powerful flush and a rimless design for the absolute highest levels of hygiene and rapid cleaning.

- Designed and engineered in Australia
- Features award-winning Caroma Cleanflush® technology - hygienic design for easy cleaning
- Patented flow balancer delivers superior flushing performance
- Available in AS1428.1 2009 accessible and ambulant options, ideal for hospital, aged care and commercial applications
- WELS 4 star rated
- 10 year commercial and domestic warranty

Visit our website to see the full range of toilet suites in the Care collection, caroma.com.au

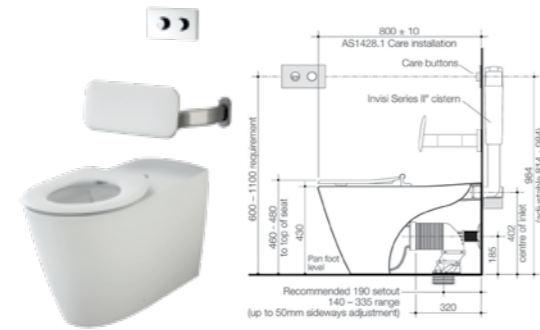

Care 800 Cleanflush® Wall Faced Invisi Series II® Suite

WELS 4 star rated, 4.5/3L (3.5L avg/flush)

Caravelle Care single flap seat

White with backrest	718320BW	○
White without backrest	718320W	○
Sorrento blue with backrest	718320BSB	●
Sorrento blue without backrest	718320SB	●
Anthracite grey with backrest	718320BAG	●
Anthracite grey without backrest	718320AG	●

Pedigree II Care single flap seat

White with backrest	718300BW	○
White without backrest	718300W	○
Sorrento blue with backrest	718300BSB	●
Sorrento blue without backrest	718300SB	●
Anthracite grey with backrest	718300BAG	●
Anthracite grey without backrest	718300AG	●



Care 800 Cleanflush® Wall Faced Toilet Suite

WELS 4 star rated, 4.5/3L (3.5L avg/flush)

Caravelle Care single flap seat

White with backrest	901920BW	○
White without backrest	901920W	○
Sorrento blue with backrest	901920BSB	●
Sorrento blue without backrest	901920SB	●
Anthracite grey with backrest	901920BAG	●
Anthracite grey without backrest	901920AG	●

Pedigree II Care single flap seat

White with backrest	901900BW	○
White without backrest	901900W	○
Sorrento blue with backrest	901900BSB	●
Sorrento blue without backrest	901900SB	●
Anthracite grey with backrest	901900BAG	●
Anthracite grey without backrest	901900AG	●



Image is representative of AS1428.1 Ambulant Installation (design for access and mobility).



Care 660 Cleanflush® Easy Height Wall Faced Suite

WELS 4 star rated, 4.5/3L (3.5L avg/flush)

Back entry cistern with double flap seat

White with armrests	846910ARW	○
White without armrests	846910W	○
Sorrento blue with armrests	846910ARSB	●
Sorrento blue without armrests	846910SB	●
Anthracite grey with armrests	846910ARAG	●
Anthracite grey without armrests	846910AG	●

Back entry cistern with single flap seat

White with armrests	846911ARW	○
White without armrests	846911W	○
Sorrento blue with armrests	846911ARSB	●
Sorrento blue without armrests	846911SB	●
Anthracite grey with armrests	846911ARAG	●
Anthracite grey without armrests	846911AG	●

Bottom inlet cistern with double flap seat

White with armrests	846912ARW	○
White without armrests	846912W	○
Sorrento blue with armrests	846912ARSB	●
Sorrento blue without armrests	846912SB	●
Anthracite grey with armrests	846912ARAG	●
Anthracite grey without armrests	846912AG	●

Bottom inlet cistern with single flap seat

White with armrests	846913ARW	○
White without armrests	846913W	○
Sorrento blue with armrests	846913ARSB	●
Sorrento blue without armrests	846913SB	●
Anthracite grey with armrests	846913ARAG	●
Anthracite grey without armrests	846913AG	●

To upgrade to nurse call armrests, add 'NCL' (left side) or 'NCR' (right side) after the product code, with armrests e.g. 846910ARWNCL

Toilet suites when used with armrests are not AS1428.1-2009 compliant.



Care 610 Cleanflush® Easy Height Connector Suite

WELS 4 star rated, 4.5/3L (3.5L avg/flush)

S trap pan with single flap seat

White with backrest	982931BW	○
White without backrest	982931W	○
Sorrento blue with backrest	982931BSB	●
Sorrento blue without backrest	982931SB	●
Anthracite grey with backrest	982931BAG	●
Anthracite grey without backrest	982931AG	●

S trap pan with double flap seat

White with backrest	982932BW	○
White without backrest	982932W	○
Sorrento blue with backrest	982932BSB	●
Sorrento blue without backrest	982932SB	●
Anthracite grey with backrest	982932BAG	●
Anthracite grey without backrest	982932AG	●

P trap pan with single flap seat

White with backrests	982941BW	○
White without backrest	982941W	○
Sorrento blue with backrest	982941BSB	●
Sorrento blue without backrest	982941SB	●
Anthracite grey with backrest	982941BAG	●
Anthracite grey without backrest	982941AG	●

P trap pan with double flap seat

White with backrest	982942BW	○
White without backrest	982942W	○
Sorrento blue with backrest	982942BSB	●
Sorrento blue without backrest	982942SB	●
Anthracite grey with backrest	982942BAG	●
Anthracite grey without backrest	982942AG	●

Nurse call button

Designed and engineered specifically for aged care facilities and hospitals, the nurse call button is fully integrated into our Caroma Care toilet suites, allowing the patient easy access to nurse assistance without the potential danger of reaching around to the wall.

Our nurse call toilet suites have been developed to remove the need for untidy traditional methods of nurse response near the toilet point, thus providing improved convenience and better living solutions for the resident or patient.

- Designed in Australia
- Fully certified IP56 rated nurse call button enclosure with fully concealed cable provides added protection against moisture in the bathroom
- LED light on button illuminates to provide reassurance for the user when pressed
- Easy to install, service and maintain
- 1 year warranty



1. The alert button is conveniently located to the side of the armrest minimising unintentional alert triggers
2. Toilet roll holder always situated on the same side as the nurse call button for added convenience
3. Cable is integrated inside armrest and includes a strain relief for cable at the base of the arm to ensure tangle free operation
4. Cable hard wired by nurse call installers (wall plate and cable gland recommended)



Basins

Our Opal Collection basins combine modern style with considered design to meet your space and storage requirements.

- Designed in Australia
- Available with integrated shelves to maximise storage in the bathroom space
- Can be installed to comply to AS1428.1 2009 Amd.1 design for access and mobility requirements
- Includes white plug and chrome waste
- 10 year warranty

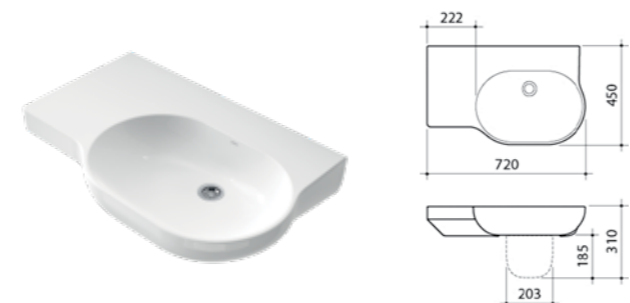

Opal 720 Wall Basin Left Hand Shelf

0 taphole 632200W
1 taphole 632210W
3 taphole 632230W

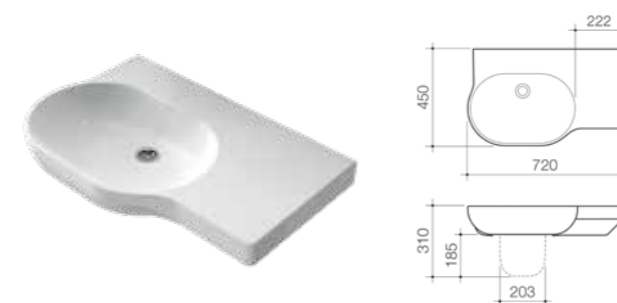

Opal 720 Wall Basin Right Hand Shelf

0 taphole 632100W
1 taphole 632110W
3 taphole 632130W

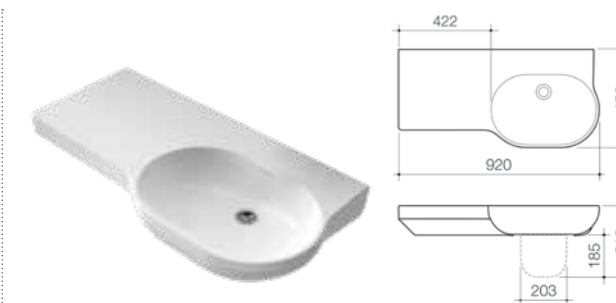

Opal 920 Wall Basin Left Hand Shelf

0 taphole 632400W
1 taphole 632410W
3 taphole 632430W

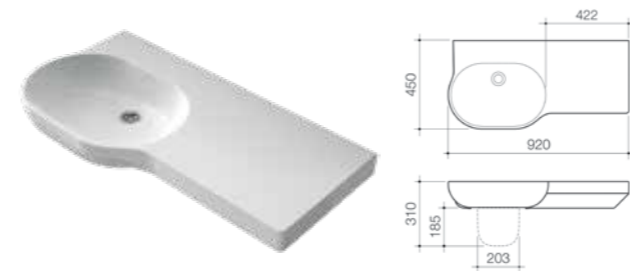

Opal 920 Wall Basin Right Hand Shelf

0 taphole 632300W
1 taphole 632310W
3 taphole 632330W

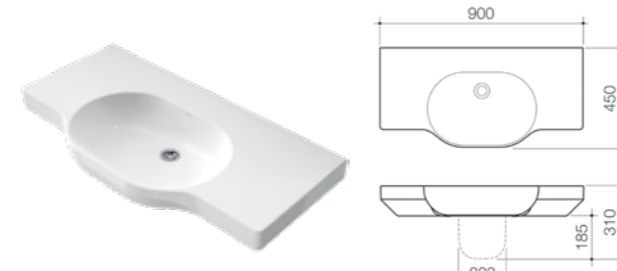

Opal 900 Twin Wall Basin

0 taphole 632500W
1 taphole 632510W
3 taphole 632530W



Opal 510 Wall Basin

0 taphole 632600W
1 taphole 632610W
3 taphole 632630W

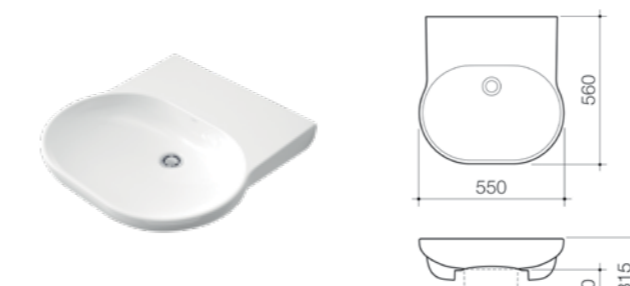

Opal Sole 550 Wall Basin

0 taphole 631700W
1 taphole 631710W
3 taphole 631730W



Opal Shroud

632601W



Basins

Basins within the Care Collection are designed to comply with the Australian Health Facility Guidelines for Infection Prevention and Control, ideal for applications in areas such as staff, patient and public amenities.

- Designed in Australia
- No overflow for increased hygiene. Anti-splash rim reduces potential splashing
- Available with integrated shelves to maximise storage in the bathroom space
- Can be installed to comply to AS1428.1 2009 Amd.1 design for access and mobility requirements
- Optional fully integrated vitreous china Care Shroud provides increased infection control and eliminates potential contraband storage (873170W)
- Includes white plug and chrome waste, suitable for hospital applications
- 10 year warranty

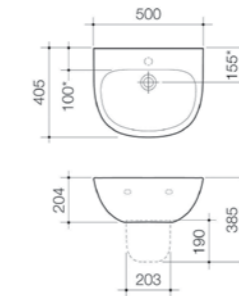

Care 500 Wall Basin

0 taphole 873200W
1 taphole 873210W

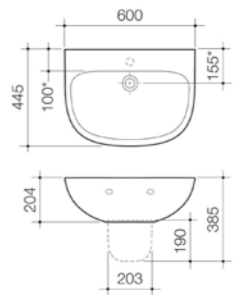

Care 600 Wall Basin

0 taphole 873100W
1 taphole 873110W

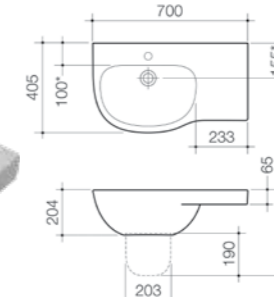

Care 700 Wall Basin with Shelf

Right hand shelf
0 taphole 873300W
1 taphole 873310W
3 taphole 873330W

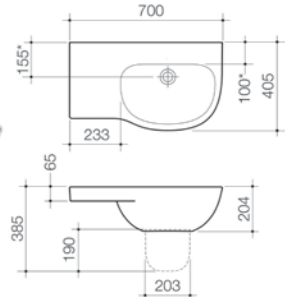

Care 700 Wall Basin with Shelf

Left hand shelf
0 taphole 873400W
1 taphole 873410W
3 taphole 873430W

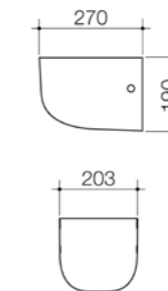

Care Shroud

873170W





Medical basins

Our medical basin collection is designed specifically for optimum infection control with easy clean surfaces for hospital and medical applications.

MEDICAL BASIN

- Designed in Australia
- Hygienic wall hung scrub up surgical basin for hospitals, clinics and industrial 'clean area' applications
- Rear waste outlet. Overflow not available for infection controlled applications
- 10 year warranty

CLINIC 600 BASIN

- Designed in Australia
- Concealed fittings and anti-splash rim
- Stainless steel vandal resistant grate included
- Hygienic clinical basin ideal for hospitals, clinics and industrial 'clean area' applications
- Overflow not available for infection controlled applications
- Can be installed to comply to AS1428.1 2009 Amd.1 design for access and mobility requirements
- 10 year warranty

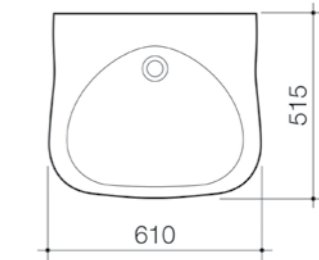

Medical Basin

0 taphole	814541W
1 taphole	814678W
3 taphole	814680W

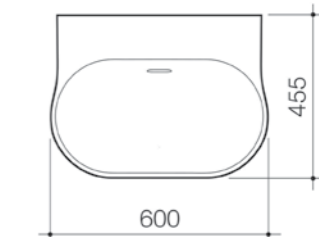
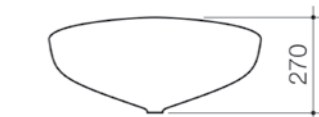

Clinic 600 Basin

0 taphole	632700W
1 taphole	632710W

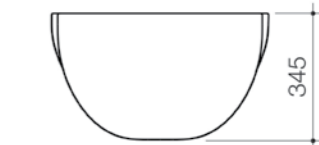

Tapware

Our Care Plus tapware provides the optimum solution in infection control for aged care and health care applications, with the inclusion of laminar flow as standard.

- 35mm adjustable cartridge for added temperature and flow control
- SoftPEX hoses provide superior durability, longer life and are free from impurities
- Laminar flow as standard for added infection control in hospitals and aged care facilities
- Larger coloured indicators on all handles, ideal for the elderly or people with vision impairments
- Options including the addition of a care handle and warm/cold indicators, ideal for vulnerable users or those with limited mobility
- Extended handle allows for AS1428.1 2009 Amd.1 design for access and mobility installations
- 10 year warranty

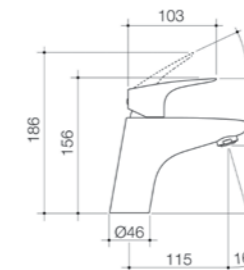

Care Plus Basin Mixer Standard Handle

WELS 6 star rated, 4.5L/min
Hot/cold 91105C6A

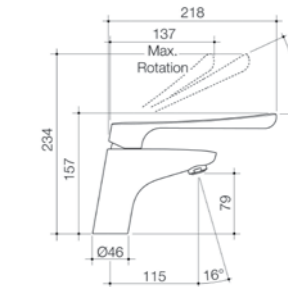

Care Plus Basin Mixer Care Handle

WELS 6 star rated, 4.5L/min
Hot/cold 91106C6A

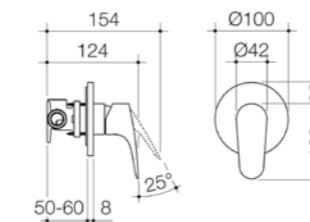

Care Plus Shower Mixer Standard Handle

Hot/cold 91107C

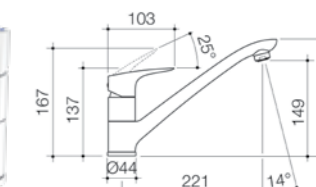

Care Plus Sink Mixer Standard Handle

WELS 4 star rated, 7.5L/min
Hot/cold 91108C4A

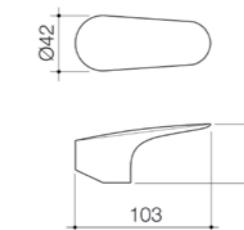

Care Plus Optional Standard Handle

Warm/cold 91109C
Hot/cold 91110C

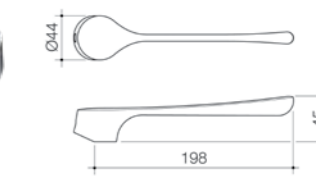

Care Plus Optional Care Handle

Warm/cold 91111C
Hot/cold 91112C



Tapware

Our Skandic tapware has been engineered to combine maximum safety with functionality and ease of use.

- 40mm adjustable ceramic disc cartridge ensures low maintenance and drip free performance
- Eco Temp cartridge for anti-scald protection
- Extended lever with large indicators available
- The anti-scald feature incorporated into the cartridge assists with the prevention of burns to vulnerable users
- Options including the addition of a care handle and warm/cold indicators, ideal for vulnerable users or those with limited mobility
- Extended handle allows for AS1428.1 2009 Amd.1 design for access and mobility installations
- 10 year warranty

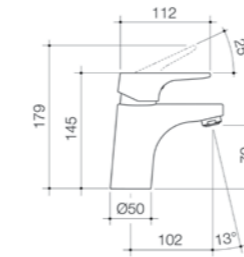

Skandic Basin Mixer

WELS 5 star rated, 6L/min
Standard basin mixer
Large indicator basin mixer
Laminar flow basin mixer
Optional warm/cold handle

90958C5A
90961C5A
90930C5A
90906C

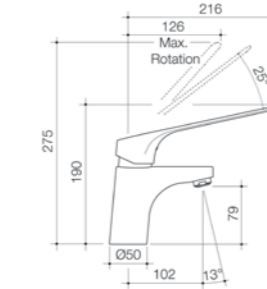

Skandic Care Basin Mixer

WELS 5 star rated, 6L/min
Hot/cold
Warm/cold

90995C5A
90994C5A

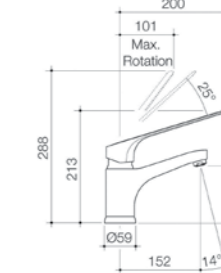

Skandic 150mm Care Basin Mixer

WELS 5 star rated, 6L/min
Hot/cold
Warm/cold

90991C5A
90993C5A

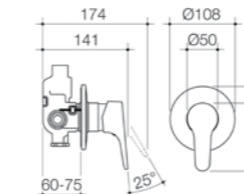

Skandic Bath/Shower Mixer

Standard bath/shower mixer
Large indicator
Optional warm/cold handle

90952C
90956C
90906C

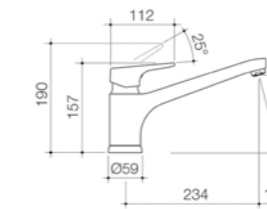

Skandic Sink Mixer

WELS 4 star rated, 7.5L/min
Standard sink mixer
Optional warm/cold handle

90959C4A
90906C

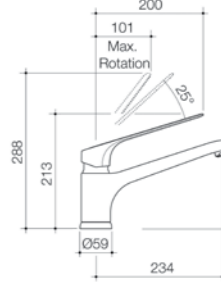

Skandic Care Sink Mixer

WELS 4 star rated, 7.5L/min
Hot/cold
Warm/cold

90996C4A
90999C4A

Caroma LiveWell also has specialty collections for people with dementia.



DEMENTIA

Dementia describes a collection of symptoms that are caused by disorders affecting the brain. It is not one specific disease.

Dementia affects thinking, behaviour and the ability to perform everyday tasks. Brain function is affected enough to interfere with the person's normal social or working life.

Source: Alzheimer's Australia

Dementia friendly tapware

Our Caravelle Classic tapware is a specialty range for people with dementia. Its classic style is designed for familiarity which is ideal for dementia sufferers.

- Easy half turn cross handle or quarter turn lever handles for those with restricted movement
- Extra-large colour indicators assist with identification for all levels of visibility
- Optional yellow handle included for warm water applications
- 10 year warranty



Caravelle Classic Basin Set

WELS 5 star rated, 6L/min
Lever Basin Set 631243C5A
Cross Basin Set 631240C5A

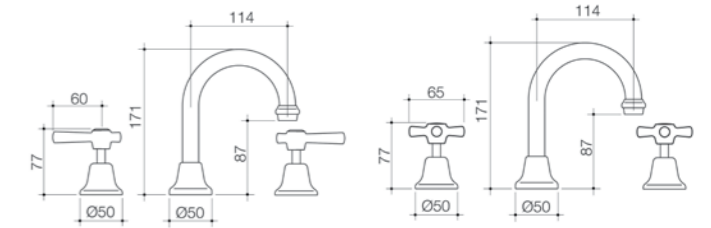

Caravelle Classic Sink Set

WELS 4 star rated, 7.5L/min
Lever Sink Set 631244C4A
Cross Sink Set 631241C4A

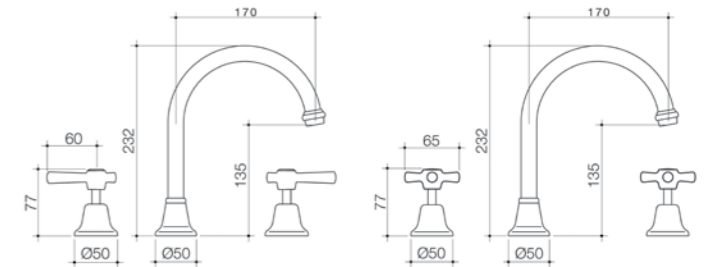

Caravelle Classic Wall Tap Set

Lever Wall Tap Set 631245C
Cross Wall Tap Set 631242C

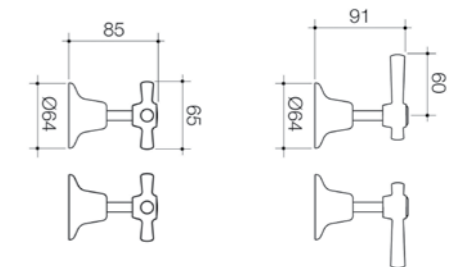

Caroma LiveWell also has specialty collections for medical professionals.



MEDICAL TAPS

Caroma LiveWell provides a collection of medical tapware ideal for the medical and healthcare industry, such as hospitals, clinics and nursing facilities. The requirements of this sector are focused on hygiene control, product performance and compliance.

Medical tapware

Our Caroma G Series+ tapware range is specifically designed for medical and healthcare applications and provides superior hygiene control, product performance and industry compliance.

- Laminar flow as standard means reduced legionella risk through a non-aerated stream
- Ceramic disc cartridges as standard, for increased ease of functionality and durability
- Extra durable handles for everyday commercial use, designed to survive the everyday pressures of life in commercial, health and medical environments which include the occasional elbow shut off
- Optional fixed or swivel spout
- More prominent colour indicators, perfect solution for aged care
- Optional yellow indicator included with each handle set providing greater flexibility at the time of install
- 10 year warranty

View our full range of G Series+ tapware at specify.caroma.com.au



G Series+ Basin Hob Set (120mm outlet + 45mm handles)
WELS 5 star rated, 6L/min
G52400C5A

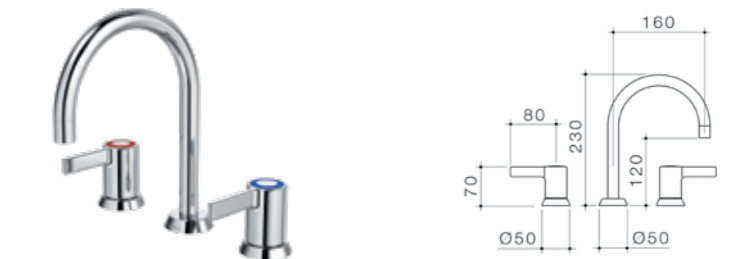

G Series+ Concealed Sink Hob Set (160mm outlet + 80mm handles)
WELS 4 star rated, 7.5L/min
G72480C4A

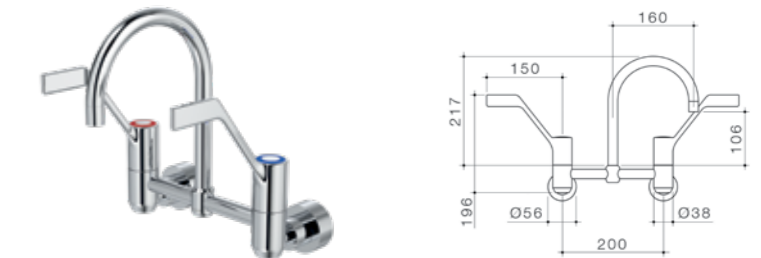

G Series+ Exposed Wall Sink Set (160mm outlet + 150mm handles)
WELS 4 star rated, 7.5L/min
G53350C4A



Support rails and shower seat

Our Opal Collection support rails are designed to enhance independence by providing additional support and balance assistance inside the home. They help prevent slips and falls in the bathroom, without compromising on style.

Our shower seat provides support and stability for those with limited mobility, giving the user more independence and comfort. The sleek, slimline design folds up out of the way when not in use.

SUPPORT AND SHOWER RAILS

- Available in a variety of lengths and angles to suit a range of locations
- Designed for support. Load bearing up to 1100N (approx. 110kg)
- 5 year warranty

SHOWER SEAT

- Non-slip surface on seat
- Maximum load 150kg
- 5 year warranty

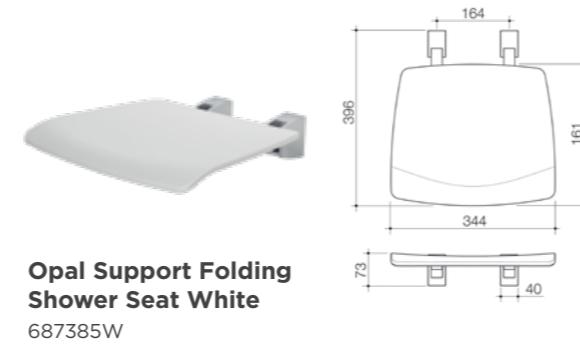

Opal Support Folding Shower Seat White
687385W

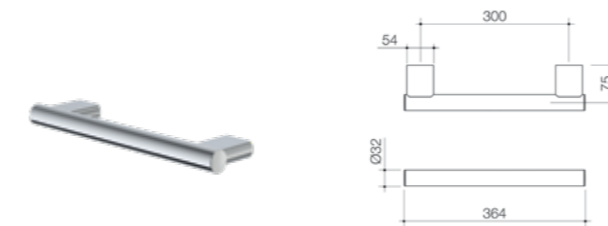

Opal Support Rail 300mm Straight
687375C

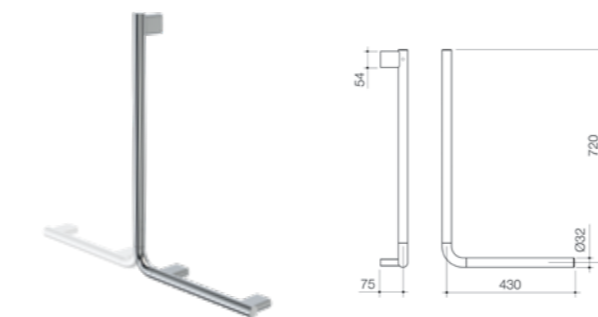

Opal Support Rail 90 Degree Left or Right Angled
687380C

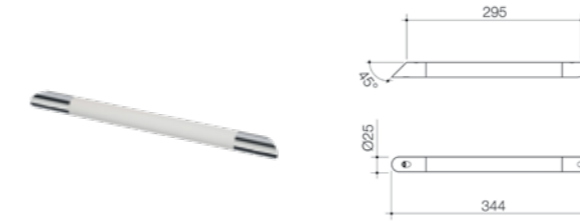

Opal Support Corner Shower Support Rail
687383W

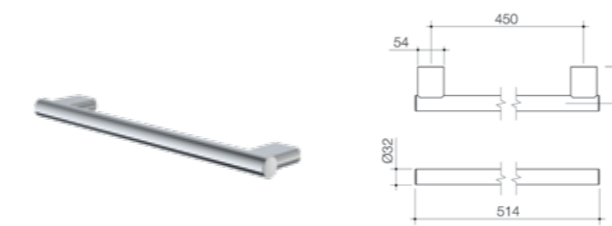

Opal Support Rail 450mm Straight
687376C

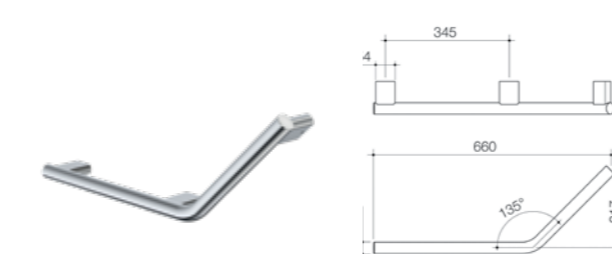

Opal Support Rail 135 Degree Left Hand Angled
687378C

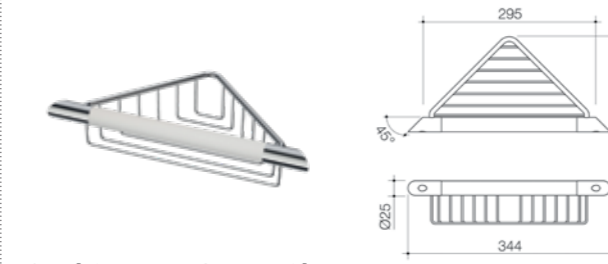

Opal Support Corner Shower Support Rail with Basket
687384W

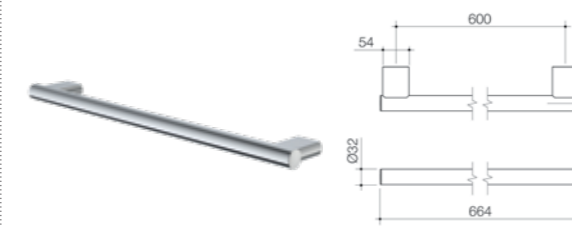

Opal Support Rail 600mm Straight
687377C

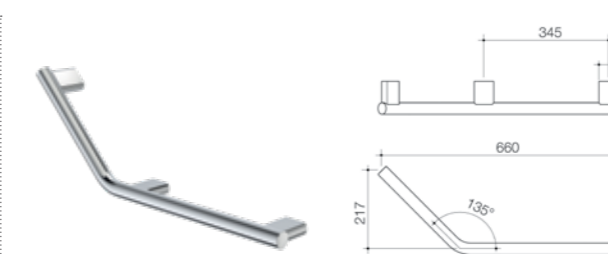

Opal Support Rail 135 Degree Right Hand Angled
687379C

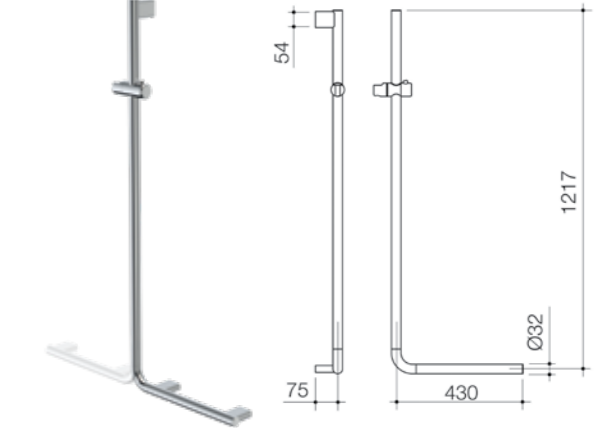

Opal Support 90 Degree Left or Right Hand Angled Shower Rail with Slider
687381C

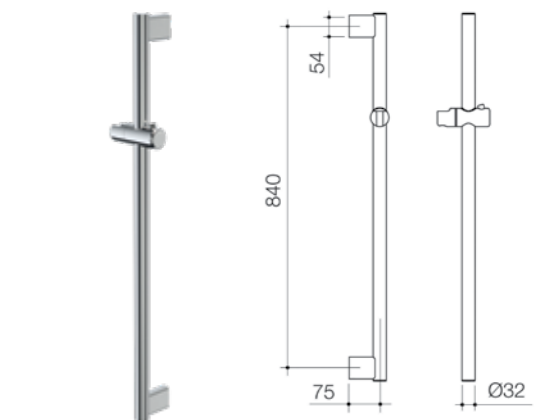

Opal Support Straight Shower Rail with Slider
687382C

Grab rails and showers

The simple style of our Virtu showers and grab rails allows them to integrate seamlessly into any bathroom space.

High quality materials for superior reliability and functionality make the collection ideal for commercial and health care applications.

SHOWERS

- Chrome shower mounted on quality stainless steel grab rail
- 32mm diameter x 1.2mm type 304 grade stainless steel rail for superior rust resistance and durability
- Silicone nozzles for easy cleaning. 1500mm robust silver chrome hose
- Rail constructed to withstand 1100N (approx. 110kg) force as per requirements
- Option to include AS1428.1 2009 compliant products
- WELS 3 star rated, 9L/min
- 5 year warranty

GRAB RAILS

- Durable metal construction with satin stainless steel finish for smooth and gentle gripping
- 32mm diameter x 1.2mm type 304L quality stainless steel with 75mm diameter concealed CLAM flanges
- Available in a variety of lengths ranging between 300mm through to 1100mm
- Designed for support. Load bearing up to 1100N (approx. 110kg), as per requirements
- Manufactured to comply with AS1428.1 2009 Amd.1 design for access and mobility requirements
- 5 year warranty

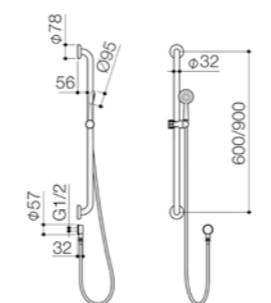

Virtu Plus Starsafe II Shower Set
WELS 3 (Range D) rated, 9L/min
600mm rail 782733A
900mm rail 782732A

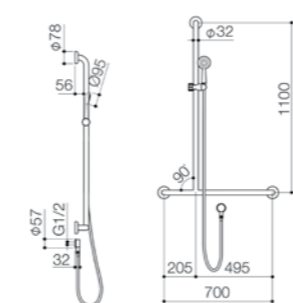

Virtu Plus Starsafe II Inverted T Shower Set
WELS 3 (Range D) rated, 9L/min
Left hand 782739A
Right hand 782738A



Virtu Comfort Grab Rail 870x700mm 140 Degree Angled
Left hand 8478475440
Right hand 8478477440

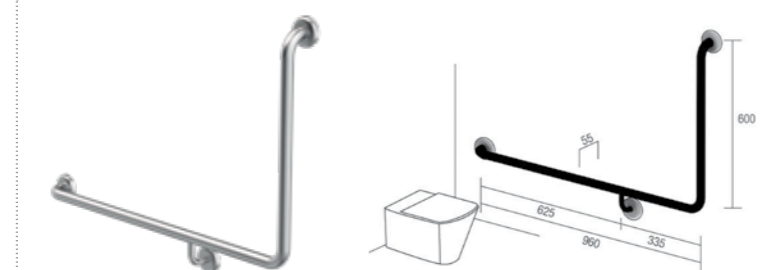

Virtu Comfort Grab Rail 960x600mm 90 Degree Vertical
Left hand 8479465440
Right hand 8479467440



Virtu Comfort Grab Rail
300mm 84730040 900mm 84790040
450mm 84745040 1000mm 84710040
600mm 84760040 1100mm 84711040
800mm 84780040





With over 75 years of experience, we believe quality bathrooms are a balance of form, function and looks. Our designs and innovation bring to life a guiding vision of creating sustainable luxury. Design that enables you to enjoy bathroom experiences that both complement and elevate your lifestyle, from an energising morning start to an indulgent, relaxing moment of luxury, all underpinned by sustainability.

Designing for Australians and New Zealanders, from all walks of life, with different tastes and needs; we have a wide range of classic to artisanal styles, smart designs and sustainable innovations providing you with everything you need to create the *sanctuary of your dreams.*

www.caroma.com.au | www.caroma.co.nz | www.specify.caroma.com.au for professionals

© Copyright 2019. Caroma Industries Ltd. ABN 35 000 189 499. All rights reserved. Material and design specifications subject to change without notice. Product colour reproduction is as near to actual product colour as production methods allow. Warning: Products in this brochure are the subject of registered designs and patents. ® is a registered trademark of Caroma Industries. This brochure relates to Australian products only and some product, design or specifications may differ in other countries.