

BATHROOMS

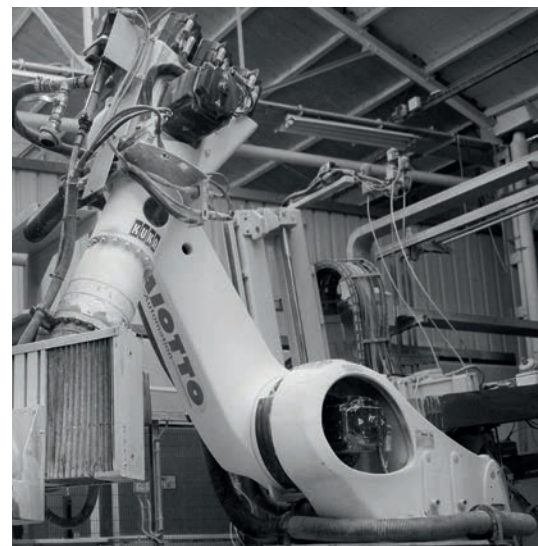

2019 DESIGN SERIES

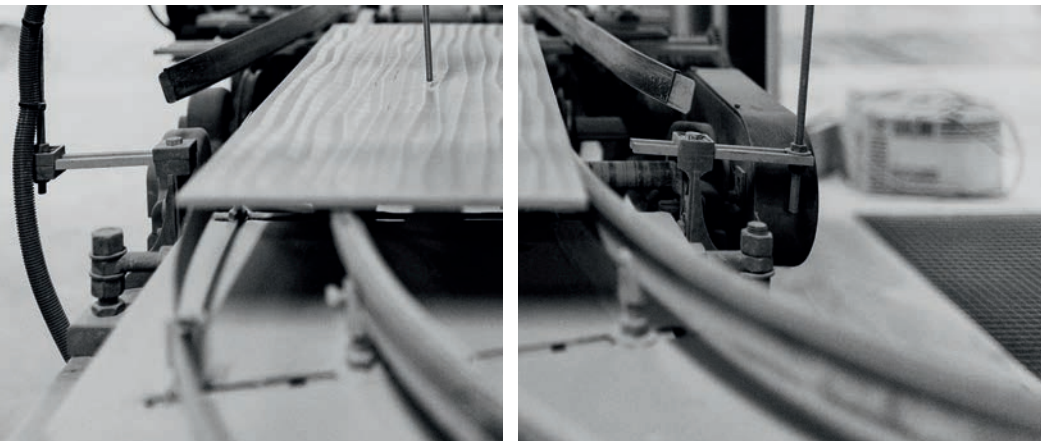

JohnsonSuisse *Bathroom Solutions*

Johnson Suisse is a subsidiary of the world's leading bathroom business, and is supported by a network of 78 factories in over 135 markets. Best known for our extensive expertise and vast range of high quality products, Johnson Suisse has become a well-known and trusted industry name. Innovation, functional design and high quality materials are at the heart of the Johnson Suisse brand and these values are maintained across the impressive portfolio of products available.

Keeping up to date with trends and consumer needs, Johnson Suisse offers ranges that will suit an array of bathroom styles, from the classic and conventional to the more modern and contemporary. Achieving a successful balance between functionality and visual excellence, Johnson Suisse aims to elevate the bathroom area into a space that is sophisticated and modern with notable features that offer convenience and comfort of the highest quality.

Johnson Suisse bathrooms – inspired designs for Australian life.

johnsonsuisse.com.au

CONTENTS

4	BASINS
22	TOILETS
	Toilet Suites
	Cisterns
	Toilet Seats
40	TAPWARE
48	ACCESSORIES
58	BATHS
68	SHOWERS
80	SHOWER INDEX
82	PRODUCT WARRANTY

BASINS

Realising the visual importance of the basin in a bathroom, JohnsonSuisse offers a wide variety of choices to suit individual preferences for any bathroom aesthetic. From simple and classic styles to the more unique and contemporary, all JohnsonSuisse basins uphold the standard of quality and style.



BASIN STYLES

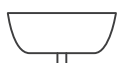

Wall Hung

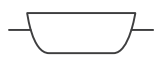

Semi-Recessed

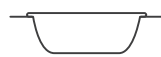

Vanity
Counter Top



Under Counter

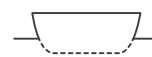

Semi-Inset

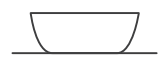

Counter Top
Vessel

BASIN FEATURES & BENEFITS

TAPWARE

Pair with our elegant tapware for a unique look



RELIABILITY

Quality and durable material

DESIGN

Elegant slant interior helps keep bowl clean

SLIM DESIGN

5mm slimness saves space so that you have more space for what matters

FLEXIBLE

various heights and sizes to meet various needs

TAPHOLES

Some basins come with 1 taphole

SHAPES

Available in Round, Square and Rectangular shapes

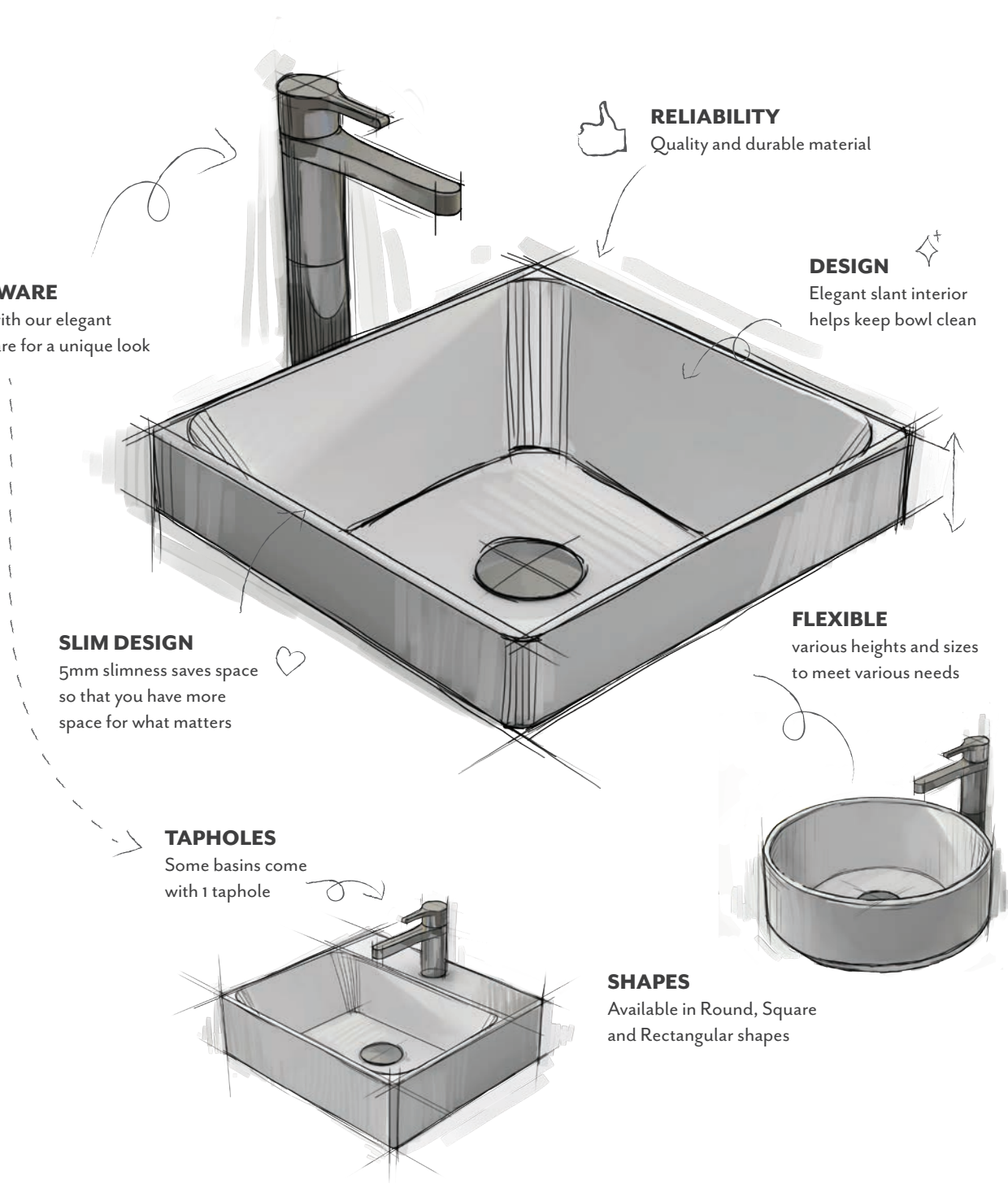



CLASSICA COMPACT

J3150 | WALL HUNG BASIN
405mm x 255mm

- Compact hand rinse basin
- Suits single mixer style tap
- Suitable in installations where space is limited
- Supplied with Chrome Pop-up Waste 32mm
- Capacity 2.2L
- 1 Taphole



QUADO COMPACT RH / LH

JBSQ840 | WALL HUNG BASIN
400mm x 230mm

- Ideal for bathrooms or powder rooms with limited space.
- With its minimalist, European styling it is perfect for those searching for a clean design with simple lines.
- The Quado Compact basin can be wall or cabinet mounted and matches perfectly with other products from the Quado range.
- Bowl capacity 2.9L
- Supplied with Chrome Pop-up Waste 32mm
- Suitable for installations where space is limited
- 1 Taphole
- No overflow



GEMELLI COMPACT

JBSG840 | WALL HUNG BASIN
400mm x 290mm

- Contemporary vitreous china basin
- Generous soap platform
- Single taphole for mixer tap
- Capacity 3.8L
- Supplied with Chrome Pop-up Waste 32mm
- 1 Taphole
- No overflow



LIFE II

JBSL849 | WALL HUNG BASIN
495mm x 410mm

- Contemporary vitreous china wall basin
- Wide soap platform
- Features modern style
- Capacity 8.3L
- Supplied with Chrome Pop-up Waste 32mm
- 1 Taphole
- No overflow



**EMILIA 450**

J3140 | WALL HUNG BASIN

455mm x 350mm

- Small to mid size contemporary standard basin
- Wide soap platform area
- Supplied with Chrome Pop-up Waste 32mm
- Capacity 3.5L
- 1 Taphole
- Can be converted to 3 Taphole at extra cost

**EMILIA 550**

J3142 | WALL HUNG BASIN

560mm x 450mm

- Mid-sized contemporary standard basin with wide soap platform area
- Matching pedestal and shroud available
- Supplied with Chrome Pop-up Waste 32mm
- Capacity 7.2L
- 1 Taphole
- Can be converted to 3 Taphole at extra cost

**EMILIA 600**

J3144 | WALL HUNG BASIN

600mm x 450mm

- Large-sized contemporary standard basin with wide soap platform area
- Matching pedestal and shroud available
- Supplied with Chrome Pop-up Waste 32mm with 40mm adapter
- Capacity 7.4L
- 1 Taphole
- Can be converted to 3 Taphole at extra cost

pictured

QUADO SEMI-INSET BASIN | *page 18*

FELINO BASIN MIXER | *page 43*



QUADO

The Quado range of Wall Hung basins are suited to a large array of bathroom styles, for both domestic and commercial applications. The rectangular shape pairs beautifully with contemporary vanities and toilet suites helping to create sleek lines throughout your bathroom. Crafted from high-quality materials, the Quado range offers a minimal style that will stand the test of time.



QUADO 450

J3160 | WALL HUNG BASIN
450mm x 390mm

- Contemporary rectangular basin
- Suitable for commercial and domestic applications
- Wide soap platform area
- Supplied with Chrome Pop-up Waste 32mm
- Capacity 4.0L
- 0/1 Taphole



QUADO 550

J3162 | WALL HUNG BASIN
550mm x 445mm

- Mid-sized contemporary styled rectangular basin with wide soap platform area
- Matching pedestal and shroud available
- Supplied with Chrome Pop-up Waste 32mm
- Capacity 6.6L
- 1 Taphole
- Can be converted to 3 Taphole at extra cost



QUADO 600

J3164 | WALL HUNG BASIN
600mm x 445mm

- Large - sized contemporary styled rectangular basin with wide soap platform area
- Matching pedestal and shroud available
- Supplied with Chrome Pop-up Waste 32mm
- Capacity 7.1L
- 1 Taphole
- Can be converted to 3 Taphole at extra cost



QUADO 800

J3166 | WALL HUNG BASIN
795mm x 445mm

- Contemporary rectangular basin
- Extra large-sized
- Dual LH/RH Shelf
- Matching pedestal and shroud available
- Supplied with Chrome Pop-up Waste 32mm
- Capacity 7.1L
- 1 Taphole
- Can be converted to 3 Taphole at extra cost



BOSTON TYPE C CARE

J3094 | WALL HUNG BASIN
500mm x 430mm

- D-shaped basin for clinic use
- Durable, hygienic glaze finish
- 0/1 taphole option
- Can be drilled to 3 tapholes
- No overflow
- Robust wall mountings
- Chrome O/Flow Plug & Waste 32/40mm included
- Capacity 10L



BOSTON TYPE B CARE

J3092 | WALL HUNG BASIN
610mm x 460mm

- Large D-shaped basin for clinic use
- Durable, hygienic glaze finish
- 0/1 taphole option
- Can be drilled to 3 tapholes
- No overflow
- Robust wall mountings
- Supplied with PW1 Chrome O/Flow Plug & Waste 32/40mm included
- Capacity 13L



COLONIAL WALL BASIN

JBSC861 | WALL HUNG BASIN
610mm x 455mm x 810mm

- Large period style vitreous china washbasin with matching pedestal
- Available with 1 taphole for mixer tapware
- Supplied with Chrome Pop - up Waste 32mm
- Bowl capacity 7.1L
- Can be converted to 3 Taphole at extra cost
- Heavy item - It is recommended that the Colonial Basin be installed in conjunction with the Colonial Pedestal to provide additional support



LUCCA SHELF LH / RH

J3170 | WALL HUNG BASIN
750mm x 470mm

- Large wall basin
- Shelf on left/right side
- Wide soap platform area
- Supplied with Chrome Pop-up Waste 32mm
- Capacity 6.6L (12L capacity for no overflow version)
- 0/1 Taphole
- Can be converted to 3 Taphole at extra cost



TOLEDO SHELF LH / RH

JBST858 | WALL HUNG BASIN
580mm x 450mm

- Large modern style vitreous china washbasin
- May be wall mounted in a corner or bench mounted
- Left or right handed models available
- Standard overflow
- Supplied with Chrome Pop - up Waste 32mm
- Bowl capacity 5.5L
- 1 Taphole



LIFE

J3065 | SEMI-RECESSED BASIN
525mm x 470mm

- Contemporary form standard semi-recessed basin
- Mid-sized with generous bowl size
- Useful flat soap platform area
- Supplied with Chrome Pop-up Waste 32mm
- Capacity 6.4L
- 1 Taphole



QUADO III

JBSQ241 | SEMI-RECESSED BASIN
410mm x 410mm

- Contemporary vitreous china semi-recessed basin
- Features modern cubic style
- Wide soap platform area
- Capacity 8.8 L
- Supplied with Chrome Pop-up Waste 32mm
- 1 Taphole
- No overflow



GEMELLI 550 RECTANGULAR

J3267 | SEMI-RECESSED BASIN
550mm x 480mm

- Rectangular contemporary semi-recessed basin
- Mid-sized with generous bowl size
- Useful flat soap platform area
- Supplied with Chrome Pop-up Waste 32mm
- Capacity 9.8L
- 1 Taphole
- Can be converted to 3 Taphole at extra cost



QUADO SQUARE

JBSQ142 | VANITY COUNTER TOP BASIN
420mm x 420mm

- Contemporary vitreous china vanity basin
- Modern squared style
- Capacity 11.4L
- Supplied with Chrome Pop-up Waste 32mm
- 1 Taphole
- No overflow



EMILIA ROUND

JBSE136 | VANITY COUNTER TOP BASIN
360mm D

- Contemporary vitreous china vanity basin
- Can also be under - counter basin
- Compact space-saving style
- No taphole - allows for bench or wall - mount tapware
- Capacity 4.4L
- Supplied with Chrome Pop-up Waste 32mm
- No overflow



EMILIA RECTANGULAR

JBSE139 | VANITY COUNTER TOP BASIN
390mm x 310mm

- Contemporary vitreous china vanity basin
- Can also be under - counter basin
- Compact space-saving style
- No taphole - allows for bench or wall - mount tapware
- Capacity 4.9L
- Supplied with Chrome Pop-up Waste 32mm
- No overflow



EMILIA OVAL

JBSE143 | VANITY COUNTER TOP BASIN
430mm x 310mm

- Contemporary vitreous china vanity basin
- Can also be under - counter basin
- Compact space-saving style
- No taphole - allows for bench or wall - mount tapware
- Capacity 5.0L
- Supplied with Chrome Pop-up Waste 32mm
- No overflow







EMILIA ROUND

JBSE236 | UNDER COUNTER BASIN
360mm D

- Contemporary vitreous china vanity basin
- Undercounter mounting type
- No taphole - allows for bench or wall mount tapware
- Capacity 7.0L
- Supplied with Chrome Pop-up Waste 32mm
- 360mm diameter
- No overflow



EMILIA SMALL OVAL

JBSE239 | UNDER COUNTER BASIN
390mm x 300mm

- Contemporary vitreous china vanity basin
- Undercounter mounting type
- No taphole - allows for bench or wall mount tapware
- Supplied with Chrome Pop-up Waste 32mm
- Capacity 4.2L
- No overflow



EMILIA RECTANGULAR

JBSE250 | UNDER COUNTER BASIN
505mm x 370mm

- Contemporary vitreous china vanity basin
- Undercounter mounting type
- No taphole - allows for bench or wall mount tapware
- Supplied with Chrome Pop-up Waste 32mm
- Capacity 10.4L
- No overflow



EMILIA LARGE OVAL

JBSE251 | UNDER COUNTER BASIN
490mm x 330mm

- Contemporary vitreous china vanity basin
- Undercounter mounting type
- No taphole - allows for bench or wall mount tapware
- Supplied with Chrome Pop-up Waste 32mm
- Capacity 8.5L
- No overflow



QUADO

J3120 | UNDER COUNTER BASIN
400mm x 300mm

- Rectangular under counter vanity basin
- Suitable for commercial and domestic applications
- Supplied with Chrome Pop-up Waste 32mm
- Capacity 7.5L
- O Taphole



QUADO

JBSQ641 | SEMI-INSET BASIN

410mm x 340mm

- Contemporary vitreous china semi-inset basin
- Features modern cubic style
- Wide soap platform area
- Available with 1 taphole
- Capacity 4.3L
- Supplied with Chrome Pop-up Waste 32mm
- 45mm above counter height
- No overflow
- 1 Taphole



GEMELLI ROUND

JBSG640 | SEMI-INSET BASIN

400mm D

- Attractive round style vitreous china vessel
- Designed for inset counter top installation
- Basin capacity 9.3L
- Supplied with Chrome Pop-up Waste 32mm
- 400mm diameter size
- 70mm above counter height
- No Taphole



GEMELLI OVAL

JBSG645 | SEMI-INSET BASIN

450mm x 410mm

- Attractive oval style vitreous china vessel
- Designed for inset counter top installation
- Standard overflow
- Basin capacity 4.9L
- Supplied with Chrome Pop-up Waste 32mm
- 70mm above counter height
- 1 Taphole



GEMELLI SQUARE

JBSG740 | SEMI-INSET BASIN
455mm x 350mm

- Attractive square style vitreous china vessel
- Designed for inset counter top installation
- Supplied with Chrome Pop-up Waste 32mm
- Basin capacity 11.5L
- 70mm above counter height
- No overflow
- No Taphole



GEMELLI 450 RECTANGLE

JBSG745 | SEMI-INSET BASIN
560mm x 450mm

- Attractive rectangular vitreous china basin
- Designed for inset counter top installation
- Standard overflow
- Basin capacity 8.0L
- Supplied with Chrome Pop-up Waste 32mm
- 70mm above counter height
- 1 Taphole



GEMELLI 550 RECTANGLE

JBSG655 | SEMI-INSET BASIN
600mm x 450mm

- Attractive rectangular vitreous china basin
- Designed for inset counter top installation
- Standard overflow
- Basin capacity 8.4L
- Supplied with Chrome Pop-up Waste 32mm
- 70mm above counter height
- 1 Taphole



QUADO SQUARE

JBSQ035 | COUNTER TOP / VESSEL BASIN
350mm x 350mm

- Contemporary vitreous china vessel basin
- Wide soap platform
- Capacity 6.6L
- Supplied with Chrome Pop-up Waste 32mm
- 135mm above the counter height
- No overflow
- 1 Taphole

Designed to blend seamlessly in your bathroom with their thin and modern lines, the Venezia basins are created with the Titanium technology an innovative ceramic technology developed to provide bolder, minimalist designs.



VENEZIA SQUARE ITH

JBSV035 | COUNTER TOP / VESSEL BASIN

350mm x 350mm

- Contemporary vitreous china vessel basin with fine lines
- Wide soap platform
- Capacity 5.9L
- Supplied with Chrome Pop-up Waste 32mm
- 1 Taphole
- 135mm above the counter height
- No overflow



VENEZIA SQUARE ITH SAND



VENEZIA SQUARE ITH ASH



VENEZIA SQUARE ITH GRAPHITE



VENEZIA ROUND BOWL

JBSV036 | COUNTER TOP / VESSEL BASIN

350mm D

- Features modern vessel style with fine lines
- Benchtop mounting permits wall or bench-top tapware fitting
- Supplied with Chrome Pop-up Waste 32mm
- Capacity 5.2L
- 135mm above the counter height
- No overflow
- No Taphole



VENEZIA ROUND BOWL SAND



VENEZIA ROUND BOWL ASH



VENEZIA ROUND BOWL GRAPHITE



VENEZIA SQUARE

JBSV038 | COUNTER TOP / VESSEL BASIN
380mm x 380mm

- Features modern angular vessel style with fine lines
- Benchtop mounting permits wall or bench-top tapware fitting
- Supplied with Chrome Pop-up Waste 32mm
- Capacity 10.4L
- 120mm above the counter height
- No overflow
- No Taphole



VENEZIA SQUARE SAND



VENEZIA SQUARE ASH

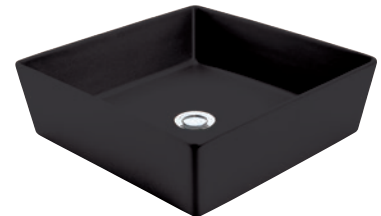

VENEZIA SQUARE GRAPHITE



VENEZIA ROUND

JBSV039 | COUNTER TOP / VESSEL BASIN
390mm D

- Features modern vessel style with fine lines
- Benchtop mounting permits wall or bench-top tapware fitting
- 32mm waste outlet with decorative china cover cap
- Capacity 8.1L
- 130mm above the counter height
- No overflow
- No Taphole



VENEZIA ROUND SAND



VENEZIA ROUND ASH



VENEZIA ROUND GRAPHITE

TOILETS

Realising the visual importance of the basin in a bathroom, JohnsonSuisse offers a wide variety of choices to suit individual preferences for any bathroom aesthetic. From simple and classic styles to the more unique and contemporary, all JohnsonSuisse basins uphold the standard of quality and style.



TOILET SUITE STYLES

- Flush to Wall
- Close Coupled
- One Piece
- Linked Vitreous China
- In-Wall Wall Faced
- In-Wall Wall Hung

FEATURES & BENEFITS

DESIGN

Simple easy - clean lines



MODERN

Smart, modern upright styling

SOFT-CLOSE SYSTEM

The WC lid with soft-close system avoids shocks and breakages

COMPACT TOILETS AND COMFORT HEIGHT TOILETS

WC with reduced measure for reduced spaces or small bathrooms and to help people with reduced mobility.



DUAL FLUSH CISTERNS

Watersaving double button to choose between a 4.5/3 l. flushing volume of water.





LIFE

J2700 | FLUSH TO WALL

- Smart, modern styling
- Simple easy-clean lines
- Flexible set out range - 90-200mm (X011H)
- Connector 180-270 mm Set Out (X011B)
- Back entry water inlet
- S or P Trap



HEART

J2580 | FLUSH TO WALL

- Smart, modern upright styling
- Simple easy-clean lines
- Supplied with New Life seat JSEL101
- Flexible set out range 90 -200mm (X011H)
- Connector 180-270 mm Set Out (X011B)
- Back entry water inlet



VENEZIA

J2320 | FLUSH TO WALL

- Smart, modern upright styling
- Simple easy-clean lines
- Supplied with Venezia seat JSEV101
- Flexible set out range 90 -195mm (X011H)
- Connector 195-225 mm Set Out (X011B)
- Back entry water inlet



TOLEDO RIMLESS

JTTT401.402 | FLUSH TO WALL

- Smartly styled flush to wall close coupled vitreous china toilet suite
- Rimless flushing system - efficient and easy to clean
- Supplied with Toledo soft close quick release seat JSET101
- Can be used in ambulant-assisted living installations with the increased seat height for comfortable use (AS1428.1 Ambulant compliant)
- Concealed back entry water inlet
- Adjustable S connector supplied for 90-175mm set out
- Optional adjustable S connector for 175-210mm set out
- Back entry and can be converted to bottom entry by using the bottom entry conversion kit XJ108



EMILIA RIMLESS

JTTE401.402 | FLUSH TO WALL

- Contemporary Rimless, vitreous china toilet suite
- Extra height and short projection makes it suitable for people with ambulant limitations
- Supplied with soft close seat as standard
- Short projection
- Concealed back entry water inlet.
- Left/right hand bottom entry conversion valve available



CIVIC

J2010.J2100C | CLOSE COUPLED

- Functional traditional design
- Compact with simple lines
- Standard close seat
- Suitable for new or replacement installations
- Secure, external cistern fixing
- L/R adjustable water inlet
- S or P Trap
- S Trap set out 140mm



PLAZA

J2010.J2200C | CLOSE COUPLED

- Functional and stylish design
- Compact with simple lines
- Suitable for new or replacement installations
- Secure, external cistern fixing
- L/R adjustable water inlet
- S or P Trap
- S Trap set out 140mm



COLONIAL II

J2010.J2400C | CLOSE COUPLED

- Colonial design close coupled suite
- Secure, external cistern fixing
- L/R water inlet
- Soft close or Timber seat
- The toilet suite will be supplied with white seat unless the seat is specified on order.



COTTAGE ONE PIECE

J4000 | ONE PIECE

- Compact design one-piece suite
- Suitable for small areas where space is limited
- Flexible set out range 90-180mm (X011H)
- Connector 180-270 mm Set Out (X011B)
- S or P Trap

pictured
COLONIAL II TOILET SUITE | page 27
QUADO 550 BASIN | page 11
FELINO BASIN MIXER | page 43





CIVIC DELUXE

J2030.J2101W | LINKED VITREOUS CHINA

- Functional stylish design
- Concealed outlet S pan matched with vitreous china cistern
- Standard close seat with fitted plastic link
- Suitable for new or replacement installations
- Flexible S Trap set out range 140-300mm
- LH/RH Adjustable water inlet
- S Trap



PLAZA DELUXE

J2030.J2201W | LINKED VITREOUS CHINA

- Functional stylish design
- Concealed outlet S pan matched with vitreous china cistern
- Soft close seat with fitted plastic link
- Suitable for new or replacement installations
- Flexible S Trap set out range 140-300mm
- LH/RH Adjustable water inlet
- S Trap



COLONIAL FEATURE

J2050.J2401 | LINKED VITREOUS CHINA

- Colonial style with embossed edging features
- Exposed chrome flush pipe
- Matching timber seat options
- Suitable for new or replacement installations
- Flexible S Trap set out range - 180-280mm
- L/R Adjustable water inlet
- S Trap

pictured
LIFE ECONOFLUSH | *page 31*
MECHANICAL PUSH BUTTON IN BLACK | *page 32*





LIFE ECONOFLUSH

J2765.J2981 | IN-WALL WALL FACED

- Contemporary styled wall-faced pan matched with an in-wall cistern
- Selection of cistern actuator buttons available
- Soft close/quick release seat
- Suitable for commercial or domestic installations
- Adjustable S Trap Connector included 60 - 90mm set out range
- S or P Trap



HEART ECONOFLUSH

J2570.J2981 | IN-WALL WALL FACED

- Contemporary styled wall-faced pan matched with an in-wall cistern
- Selection of cistern actuator buttons available
- Soft close/quick release seat
- Suitable for commercial or domestic installations
- Extended push-button rods
- Adjustable S Trap Connector included 60 - 90mm set out range
- S or P Trap



GEMELLI ECONOFLUSH (RIMLESS)

JTTG701.J2986 | IN-WALL WALL HUNG

- No rim, no blockage, no hassle
- Easy clean design
- Powerful hygienic motion flush
- Controlled water flow eliminates splash back
- Clean design with concealed trap
- Top - fixed soft close seat
- High - quality mechanical push buttons (available separately)



TOLEDO (RIMLESS)

JTTT601 | WALL FACED PAN

- Rimless wall-faced pan
- Suitable for commercial or domestic applications if installed with inwall cistern
- Extra-height pan suitable for assisted living/ ambulant installations

CREATE YOUR PERFECT SYSTEM

CONCEALED CISTERNS

Combine one of our wall - faced pans with the Econoflush range of concealed cisterns to give your bathroom the ultimate in minimalist and contemporary bathroom fashion. A variety of button options are available to suit your personal bathroom style and layout. The Econoflush Air with Pneumatic activation also allows the flush buttons to be located remotely (up to 2 metres) away from the cistern for the perfect solution to assisted living applications.

For our full range of concealed cisterns please visit page 35.



MECHANICAL PUSH BUTTONS

Our full range of Mechanical Push Buttons to be used in conjunction with Econoflush In-Wall cisterns.

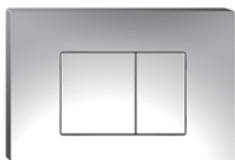

RECTANGLE HIGH BUTTON

245mm x 165mm

Chrome JB60C
Matte JB60M



RECTANGLE LOW BUTTON

245mm x 165mm

Chrome JB50C
Matte JB50M
Black JB50B
White JB50W



CIRCLE BUTTON

245mm x 165mm

Chrome JB80C
Matte JB80M
Black JB80B
White JB80W



STEP BUTTON

245mm x 165mm

Chrome JB40C
Matte JB40M



ROUND SQUARE BUTTON

245mm x 165mm

Chrome JB70C
Matte JB70M
Black JB70B
White JB70W



PNEUMATIC PUSH BUTTONS

Buttons can be located up to 2 metres from toilet suite for pneumatic activation.



RAISED BUTTON BLUE

210mm x 140mm

JB90B



RAISED BUTTON CHROME

210mm x 140mm

JB90C



FLAT BUTTON

210mm x 140mm

JB92W (White)
JB92C (Polished Chrome)
JB92M (Matte Chrome)



FLAT BUTTON BLACK

210mm x 140mm

JB92BLK



CIVIC

J2101W | WALL MOUNT VC

- Vitreous china wall mounted cistern
- Designed for general purpose use
- Plastic seat, link, flush pipe and seals
- 4.5/3L flushing, convertible to 6.0/3L
- Efficient reliable flushing performance
- LH / RH water inlet



PLAZA

J2201W | WALL MOUNT VC

- Vitreous china wall mounted cistern
- Designed for general purpose use
- Plastic seat, link, flush pipe and seals
- 4.5/3L flushing, convertible to 6.0/3L
- Efficient reliable flushing performance
- Soft-close seat



COLONIAL FEATURE

J2401M | WALL MOUNT VC

- Period style vitreous china wall mounted cistern
- Efficient reliable flushing performance
- 4.5/3L Dual flush
- LH/RH water inlet
- Can be used in a close coupled configuration in the Colonial Close Coupled suite
- Convertible to 6/3L
- Can be used as a wall-mounted unit in the Colonial Feature suite



PULL CHAIN

RG21015PC | WALL MOUNT PLASTIC

- Plastic wall mounted high level urinal cistern
- Pull - chain flushing
- 1.5-2.0L flushing
- Efficient reliable flushing performance
- Includes 19mm pipe reducer



ECONOFLUSH AIR UNFRAMED (PNEUMATIC)

J2982 | IN-WALL CISTERN

- Concealed in-wall cistern with integrated mounting/pan fixing frame
- Space efficient and suitable for commercial or domestic installations
- Can be matched with a variety of wall-faced pans
- Selection of cistern actuator buttons available
- Optional remote pneumatic cistern actuation - buttons can be connected via air tube (4m long)
- See page 33 for Pneumatic Buttons



ECONOFLUSH UNFRAMED

J2981 | IN-WALL CISTERN

- Unframed concealed in-wall cistern
- Space efficient and suitable for commercial or domestic installations
- Can be matched with a variety of wall-faced pans
- Selection of cistern actuator buttons available
- See page 32 for Mechanical Buttons

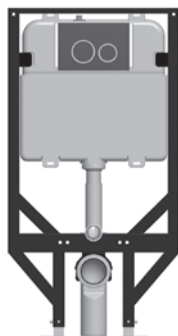

ECONOFLUSH FRAMED

J2986 | IN-WALL CISTERN

- Concealed in-wall cistern with integrated mounting/pan fixing frame
- Space efficient and suitable for commercial or domestic installations
- Can be matched with a variety of wall-hung pans
- S/P pan connectors and pan fixing bolts included
- Selection of cistern actuator buttons available
- See page 32 for Mechanical Buttons



REMOTE INSTALLATION KIT FOR PNEUMATIC BUTTON

JB92K

- Specifically purposed to enable the mounting of Pneumatic Buttons | anywhere in your bathroom yet still have access to the cistern.
- Available for Induct, Inceiling, Inwall or Undercounter installations
- Ideal for applications where space is a premium
- Buttons and panels Sold Separately
- See page 33 for Pneumatic Buttons



SELECT / PLAZA DELUXE LINK

RB1038SC | TOILET SEAT

- Thermo-Plastic moulded medium duty
- Plastic hinges
- Includes link piece

LUTON

J2802 | TOILET SEAT

- Thermo-Plastic moulded seat with bolt through stainless steel hinges
- Attractive and Practical

COLONIAL TIMBER

3000 | TOILET SEAT

- Wooden seat (mahogany or oak stain)
- Chrome hinges



PLAZA

RB6041 | TOILET SEAT

- Compression moulded seat
- Four moulded buffers
- Concealed top-fix soft close hinges with quick release
- Black rubber inserts XJ179B x 2



TOLEDO

JSET101 | TOILET SEAT

- Top-fix, soft close quick release seat
- Duroplast (Urea) material



VENEZIA FTW

JSEv101 | TOILET SEAT

- Specific design for Venezia Flush To Wall Suite
- Compression moulded heavy duty
- Anti-bacterial
- Soft close, Quick release



EMILIA

JSEE101 | TOILET SEAT

- Top-fix, soft close, quick release



NEW HEART

JSEH101 | TOILET SEAT

- Compression moulded seat
- Top-fixed with soft close hinges
- Quick release mechanism for easy cleaning



NEW LIFE

JSEL101 | TOILET SEAT

- Compression moulded seat
- Top-fixed with soft close hinges
- Quick release mechanism for easy cleaning
- Slim-line Design



PLAZA ASSIST

RB6015 | TOILET SEAT

- Compression moulded seat with two moulded buffers
- Bolt-through stainless steel top fix hinges
- Includes adjustable lateral stabilisers



PLAZA ASSIST GREY



PLAZA ASSIST BLUE



LIFE ASSIST

RB6044W | TOILET SEAT

- Compression moulded seat with two moulded buffers
- Bolt-through stainless steel top fix hinges
- Includes adjustable lateral stabilisers

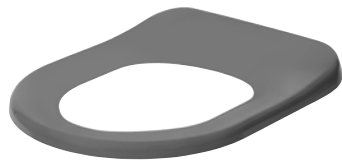

LIFE ASSIST GREY



LIFE ASSIST BLUE



PLAZA XTRA

JSEP101 | TOILET SEAT

- Comfortable ergonomic design
- Converts standard height toilet pans to extra-height
- Soft-close hinge system
- Integrated seat stabilisers
- Hygienic anti-bacterial finish
- Robust and durable
- Secure, vandal resistant fixing options
- Easy DIY installation
- Suitable as a retro-fit replacement



TAPWARE

Realising the visual importance of the basin in a bathroom, JohnsonSuisse offers a wide variety of choices to suit individual preferences for any bathroom aesthetic. From simple and classic styles to the more unique and contemporary, all JohnsonSuisse basins uphold the standard of quality and style.



TAPWARE STYLES

- Basin Mixer
- Raised Height Basin Mixer
- Sink Mixers
- Shower Mixers
- Diverter Mixers
- Bath Spouts
- Hand Showers

FEATURES & BENEFITS

RELIABILITY

- High chrome finish with anti-scratching and mirror effect



DURABILITY

- Developed under stringent, quality control processes. High resistance against corrosion and water limescale



HEALTH

- Made of DZR Brass Material to prevent migration of hazardous materials to water

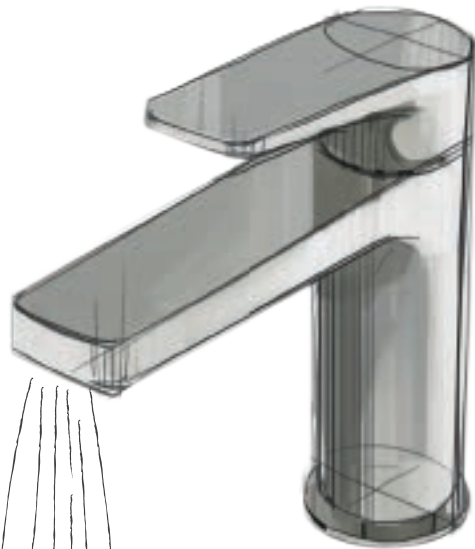

Various heights and sizes to meet various needs

SUSTAINABILITY

- Made with maximum respect and consideration for the environment



FLEXIBLE

- Multiple combinations of designs and heights available



FELINO BASIN MIXER

JTFL121 | TAPWARE

- Attractively styled sink mixer with a swivel spout
- Single lever activation with a flat lever design style
- Quality 35mm diameter ceramic disc provides accurate flow and mixing temperature control
- Simple water supply connection via two fitted flexihoses
- Easy-to-use backnut arrangement for simple fitting



FELINO SINK MIXER

JTFL423 | TAPWARE

- Attractively styled sink mixer with a swivel spout
- Single lever activation with a flat lever design style
- Quality 35mm diameter ceramic disc provides accurate flow and mixing temperature control
- Simple water supply connection via two fitted flexihoses
- Easy-to-use backnut arrangement for simple fitting



FELINO CONCEALED SHOWER MIXER

JTFL705 | TAPWARE

- Attractively styled shower mixer
- Non-diverter model
- Contemporary angular design
- Easy single lever activation with a flat lever design style
- Quality 35mm diameter ceramic disc provides accurate flow and mixing temperature control
- Simple water installation and straightforward water connection



FELINO CONCEALED DIVERTER MIXER

JTFL605 | TAPWARE

- Attractively styled shower mixer
- Incorporates a diverter for bath filling
- Contemporary angular design
- Easy single lever activation with a flat lever design style
- Quality 35mm diameter ceramic disc provides accurate flow and mixing temperature control
- Simple water installation and straightforward water connection



FERLA BASIN MIXER

JTFR121 | TAPWARE

- Attractively styled basin mixer with a fixed spout
- Single lever activation with a flat lever design style
- Fitted aerator in spout
- Quality 35mm diameter ceramic disc provides accurate flow and mixing temperature control
- Simple water supply connection via two fitted flexihoses
- Easy-to-use backnut arrangement for simple fitting



FERLA TALL BASIN MIXER

JTFR223 | TAPWARE

- Attractively styled basin mixer with a fixed spout
- Single lever activation with a flat lever design style
- Extra height suitable for bench mounting with vessel type basins
- Fitted aerator in spout
- Quality 35mm diameter ceramic disc provides accurate flow and mixing temperature control
- Simple water supply connection via two fitted flexi hoses
- Easy-to-use backnut arrangement for simple fitting



FERLA CONCEALED SHOWER MIXER

JTFR705 | TAPWARE

- Attractively styled shower mixer
- Non - diverter model
- Matches Ferla Basin Mixer tapware
- Oval format
- Easy single lever activation with a flat lever design style
- Quality 35mm diameter ceramic disc provides accurate flow and mixing
- Temperature control
- Simple water installation and straightforward water connection



FERLA CONCEALED DIVERTER MIXER

JTFR605 | TAPWARE

- Attractively styled shower mixer
- Incorporates a diverter for bath or shower delivery
- Oval escutcheon format
- Easy single lever activation with a flat lever design style
- Quality 35mm diameter ceramic disc provides accurate flow and mixing
- Temperature control
- Simple water installation and straightforward water connection



FERLA SINK MIXER SQUARE

JTFR423 | TAPWARE

- Attractively styled sink mixer with a swivel spout
- Extra height suitable for bench mounting
- Single lever activation with a flat lever design style
- Quality 35mm diameter ceramic disc provides accurate flow and mixing temperature control
- Simple water supply connection via two fitted flexihoses
- Easy-to-use backnut arrangement for simple fitting

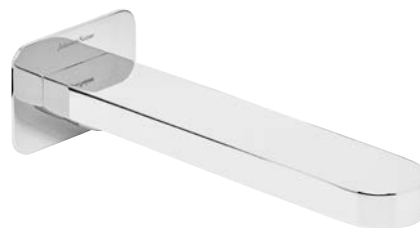

FERLA/FELINO BATH SPOUT

JTFN02 | TAPWARE

- Attractively styled fixed bath spout
- Matches Ferla / Felino mixer tapware
- Aerator integrated in spout
- Standard water supply connection via G1/2" F fitting



**FERLA/ FELINO SHOWER HEAD
RECTANGULAR**

JTFN12 | TAPWARE

- Attractively styled rainshower head
- 300 x 200mm rectangular format
- Chrome finished face with silicone nozzles
- Matches Ferla or Felino tapware



**FERLA/FELINO 3 FUNCTION HAND
SHOWER WITH HOSE & BRACKET**

JTFN16 | TAPWARE

- Chrome finished 3 function hand shower with silicon nozzles
- Chrome plated wall bracket / water outlet
- Quality shower hose
- Matches Ferla or Felino tapware



**FERLA/FELINO 3 FUNCTION HAND
SHOWER SET WITH BACK-FLOW
PREVENTION DEVICE**

JTFN18 | TAPWARE

- Chrome finished ABS triple function hand shower
- Chrome plated, water inlet fitting (wall mounted) with Back-Flow prevention device
- 1.7m chrome finished shower hose
- Hand shower - attractive chrome face and silicone nozzles



**FERLA / FELINO 3 FUNCTION HAND
SHOWER WITH HOSE, SLIDING RAIL
& WATER INLET**

JTFN14 | TAPWARE

- Chrome finished 3 function hand shower with silicone nozzles
- Adjustable height shower rail
- Chrome plated wall fitting / water outlet
- Quality shower hose
- Matches Ferla or Felino tapware



pictured top

CUBE SINGLE TOWEL RAIL | *page 51*

middle

CUBE TEMPERED GLASS SHELF | *page 52*

bottom

SWIFT DOUBLE TOWEL RAIL | *page 56*

ACCESSORIES

Realising the visual importance of the basin in a bathroom, JohnsonSuisse offers a wide variety of choices to suit individual preferences for any bathroom aesthetic. From simple and classic styles to the more unique and contemporary, all JohnsonSuisse basins uphold the standard of quality and style.



ACCESSORIES
BATHROOMS



CUBE TOILET ROLL HOLDER RIGHT

GDC160156 | ACCESSORIES

- Functional and stylish design
- Single toilet roll holder
- Durable chrome finish
- Secure concealed DIY fixing system
- Other matching accessories available
- 10 year warranty



CUBE DOUBLE TOILET ROLL HOLDER

GDC160155 | ACCESSORIES

- Functional and stylish design
- Smart design to store two toilet rolls
- Durable chrome finish
- Secure concealed DIY fixing system
- Other matching accessories available
- 10 year warranty



CUBE ROBE HOOK

GDC160121 | ACCESSORIES

- Functional and stylish design
- Attractive single robe hook
- Durable chrome finish
- Secure concealed DIY fixing system
- Other matching accessories available
- 10 year warranty



CUBE DOUBLE ROBE HOOK

GDC160122 | ACCESSORIES

- Functional and stylish design
- Attractive double robe hook
- Durable chrome finish
- Secure concealed DIY fixing system
- Other matching accessories available
- 10 year warranty



CUBE WIRE SOAP RACK

GDC160149 | ACCESSORIES

- Functional and stylish design
- Open draining soap rack suits shower / bath installation
- Durable chrome finish
- Secure concealed DIY fixing system
- Other matching accessories available
- 10 year warranty



CUBE TOWEL RING

GDCI60172 | ACCESSORIES

- Functional and stylish design
- Hand towel ring
- Durable chrome finish
- Secure concealed DIY fixing system
- Other matching accessories available
- 10 year warranty

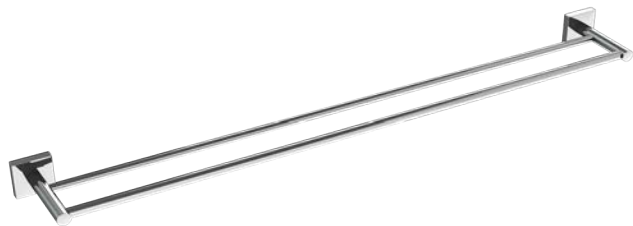

CUBE DOUBLE TOWEL RAIL 800MM

GDCI60161 | ACCESSORIES

- Functional and stylish design
- Double towel rail
- Durable chrome finish
- Secure concealed DIY fixing system
- Other matching accessories available
- 10 year warranty



CUBE SINGLE TOWEL RAIL 600MM

GDCI60165 | ACCESSORIES

- Functional and stylish design
- Single bar towel rail
- Durable chrome finish
- Secure concealed DIY fixing system
- Other matching accessories available
- 10 year warranty



CUBE SINGLE TOWEL RAIL 800MM

GDCI60166 | ACCESSORIES

- Functional and stylish design
- Single bar towel rail
- Durable chrome finish
- Secure concealed DIY fixing system
- Other matching accessories available
- 10 year warranty



CUBE TEMPERED GLASS SHELF 400MM

GDCI60144 | ACCESSORIES

- Functional and stylish design
- 400 x 100 tempered glass shelf
- Frosted glass
- Durable chrome trim
- Secure concealed DIY fixing system
- Other matching accessories available
- 10 year warranty



CUBE TEMPERED GLASS SHELF 570MM

GDCI60145 | ACCESSORIES

- Functional and stylish design
- 570 x 100 tempered glass shelf
- Frosted glass
- Durable chrome trim
- Secure concealed DIY fixing system
- Other matching accessories available
- 10 year warranty



CUBE WALL TOILET BRUSH WITH HOLDER

GDC160100 | ACCESSORIES

- Functional and stylish design
- Toilet brush in frosted glass holder
- Durable chrome trim
- Secure concealed DIY fixing system
- Other matching accessories available
- Tempered glass
- 10 year warranty



CUBE WALL GLASS SOAP DISPENSER

GDC160105 | ACCESSORIES

- Functional and stylish design
- Frosted glass soap pump dispenser
- Durable chrome trim
- Secure concealed DIY fixing system
- Other matching accessories available
- Tempered glass
- 10 year warranty



CUBE WALL TUMBLER

GDC160152 | ACCESSORIES

- Functional and stylish design
- Attractive frosted glass tumbler and holder
- Durable chrome trim
- Secure concealed DIY fixing system
- Other matching accessories available
- Tempered glass
- 10 year warranty



CUBE WALL SOAP DISH

GDC160132 | ACCESSORIES

- Functional and stylish design
- Modern frosted glass soap holder
- Durable chrome trim
- Secure concealed DIY fixing system
- Other matching accessories available
- Tempered glass
- 10 year warranty



SWIFT TOILET ROLL HOLDER RIGHT

GDCI50156 | ACCESSORIES

- Functional and stylish design
- Single toilet roll holder
- Durable chrome finish
- Secure concealed DIY fixing system
- Other matching accessories available
- 10 year warranty



SWIFT DOUBLE TOILET ROLL HOLDER

GDCI50155 | ACCESSORIES

- Functional and stylish design
- Smart design to store two toilet rolls
- Durable chrome finish
- Secure concealed DIY fixing system
- Other matching accessories available
- 10 year warranty



SWIFT ROBE HOOK

GDCI50121 | ACCESSORIES

- Functional and stylish design
- Round single robe hook
- Durable chrome finish
- Secure concealed DIY fixing system
- Other matching accessories available
- 10 year warranty



SWIFT DOUBLE ROBE HOOK

GDCI50122 | ACCESSORIES

- Functional and stylish design
- Attractive double robe hook
- Durable chrome finish
- Secure concealed DIY fixing system
- Other matching accessories available
- 10 year warranty



SWIFT WIRE SOAP RACK

GDCI50187 | ACCESSORIES

- Functional and stylish design
- Open draining soap rack suits shower/bath installation
- Durable chrome finish
- Secure concealed DIY fixing system
- Other matching accessories available
- 10 year warranty



SWIFT TOWEL RING

GDCI50172 | ACCESSORIES

- Functional and stylish design
- Hand towel ring
- Durable chrome finish
- Secure concealed DIY fixing system
- Other matching accessories available
- 10 year warranty



SWIFT SINGLE TOWEL RAIL 600MM

GDCI50165 | ACCESSORIES

- Functional and stylish design
- Single bar towel rail
- Durable chrome finish
- Secure concealed DIY fixing system
- Other matching accessories available
- 10 year warranty



SWIFT SINGLE TOWEL RAIL 800MM

GDCI50166 | ACCESSORIES

- Functional and stylish design
- Extra long single bar towel rail
- Durable chrome finish
- Secure concealed DIY fixing system
- Other matching accessories available
- 10 year warranty

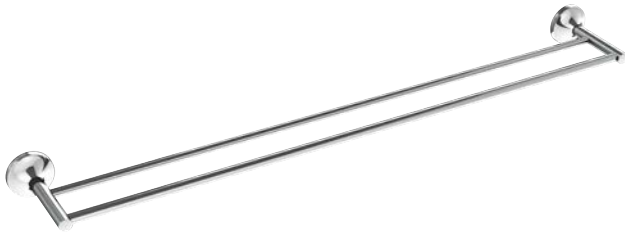

SWIFT DOUBLE TOWEL RAIL 800MM

GDCI50161 | ACCESSORIES

- Functional and stylish design
- Double bar towel rail
- Durable chrome finish
- Secure concealed DIY fixing system
- Other matching accessories available
- 10 year warranty

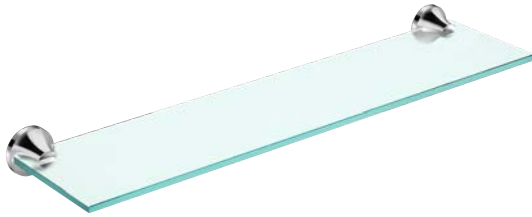

SWIFT TEMPERED GLASS SHELF 400MM

GDCI50144 | ACCESSORIES

- Functional and stylish design
- Durable chrome trim
- Secure concealed DIY fixing system
- Other matching accessories available
- Tempered glass
- 10 year warranty

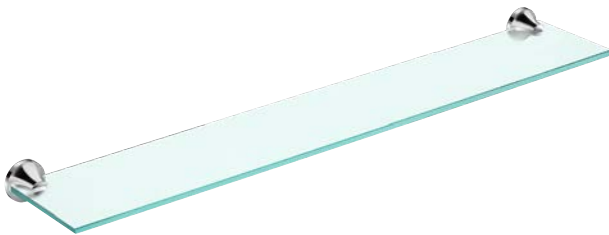

SWIFT TEMPERED GLASS SHELF 600MM

GDCI50145 | ACCESSORIES

- Functional and stylish design
- Durable chrome trim
- Secure concealed DIY fixing system
- Other matching accessories available
- 10 year warranty



HEATED TOWEL RAIL CURVED

HTCR05-01C | ACCESSORIES

- Attractive 5 bar heated towel rail
- Convenient curved rails
- Polished stainless steel tubing
- Simple concealed fixing system
- Optional plug-in or fixed wiring installation
- IP45 rating 65W



HEATED TOWEL RAIL STRAIGHT

HTCR05-01S | ACCESSORIES

- Attractive 5 bar heated towel rail
- Polished stainless steel tubing
- Simple concealed fixing system
- Optional plug-in or fixed wiring installation
- IP45 rating 65W



SWIFT WALL TOILET BRUSH WITH HOLDER

GDC150100 | ACCESSORIES

- Functional and stylish design
- Toilet brush in frosted glass holder
- Durable chrome trim
- Secure concealed DIY fixing system
- Other matching accessories available
- Tempered glass
- 10 year warranty



SWIFT WALL GLASS SOAP DISPENSER

GDC150105 | ACCESSORIES

- Functional and stylish design
- Frosted glass soap pump dispenser
- Durable chrome trim
- Secure concealed DIY fixing system
- Other matching accessories available
- Tempered glass
- 10 year warranty



SWIFT WALL TUMBLER

GDC150152 | ACCESSORIES

- Functional and stylish design
- Attractive frosted glass tumbler and holder
- Durable chrome trim
- Secure concealed DIY fixing system
- Other matching accessories available
- Tempered glass
- 10 year warranty



SWIFT WALL SOAP DISH

GDC150132 | ACCESSORIES

- Functional and stylish design
- Modern frosted glass soap holder
- Durable chrome trim
- Secure concealed DIY fixing system
- Other matching accessories available
- Tempered glass
- 10 year warranty



BATHS

Realising the visual importance of the basin in a bathroom, JohnsonSuisse offers a wide variety of choices to suit individual preferences for any bathroom aesthetic. From simple and classic styles to the more unique and contemporary, all JohnsonSuisse basins uphold the standard of quality and style.



BATH STYLES

Acrylic Freestanding

Acrylic Inset

Vitreous Enamelled Steel

FEATURES & BENEFITS

DESIGN TECHNOLOGY

Lucite sanitary grade acrylic features cross-link technology, ensuring your bath's acrylic polymer chains will not be dissolved from solvents, unlike ordinary acrylics which are simply layered.



STYLISH

Contemporary freestanding bath design



QUALITY

Quality European manufactured pressed steel bath



DURABLE

Durable scratch resistant vitreous enamelled finish

EASY INSTALLATION

Integrated self-supporting base board for easy installation



TIVOLI FREESTANDING BATH

D3WHWHS | 1500

1500mm (L) x 700mm (W) x 570mm (H) / Capacity 178L

D3WHWHM | 1700

1700mm (L) x 700mm (W) x 610mm (H) / Capacity 216L

- Contemporary freestanding bath design
- Sidewall and bath seamlessly fused together
- Lucite sanitary grade acrylic with fibreglass reinforced with polyester resins
- Chrome pop-up waste and overflow
- Adjustable legs - fully self supporting



PALERMO FREESTANDING BATH 1600

D7WHWHM | FREESTANDING BATH

1600mm (L) x 800mm (W) x 600mm (H)

- Contemporary freestanding rectangular bath design
- Sidewall and bath seamlessly fused together
- Lucite sanitary grade acrylic with fibreglass reinforced with polyester resins
- Chrome pop-up waste and overflow
- Adjustable legs - fully self supporting
- Capacity 262L
- Centre outlet



CORSICA FREESTANDING BATH

D5WHWHS | 1500

1500mm (L) x 800mm (W) x 600mm (H) / Capacity 250L

D5WHWHM | 1700

1700mm (L) x 800mm (W) x 600mm (H) / Capacity 294L

- Contemporary freestanding rectangular bath design
- Sidewall and bath seamlessly fused together
- Lucite sanitary grade acrylic with fibreglass reinforced with polyester resins
- Chrome pop-up waste and overflow
- Adjustable legs - fully self supporting
- Centre outlet

pictured

COLONIAL FREESTANDING BATH | page 63

COLONIAL II TOILET SUITE | page 27

COLONIAL WALL BASIN | page 12



GEMELLI FREESTANDING BATH

JBTG2150 | 1500

JBTG2170 | 1700

- Luxury European style acrylic bath
- Freestanding design incorporating a convenient platform shelf
- Durable scratch-resistant sanitary grade acrylic material
- Lucite sanitary grade acrylic with fibreglass reinforced with polyester resins
- Generous depth and 200/260L capacity for 1500/1700 models
- Simple installation with four concealed screw-adjustable legs
- Supplied with 40mm PW8 flexible waste connector with pop-down plug



VENEZIA WALL FACED

JBTV3166 | ACRYLIC WALL FACED

- Luxury European style acrylic bath
- Wall faced design incorporating a convenient platform shelf
- Tile lip on wall side to improve waterproofing around bath
- Durable scratch-resistant sanitary grade acrylic material
- Lucite sanitary grade acrylic with fibreglass reinforced with polyester resins
- Generous depth and 425L capacity
- Simple installation with four concealed screw-adjustable legs
- Supplied with 40mm PW8 flexible waste connector with pop-down plug



JBTC2152.C



JBTC2152.B

COLONIAL FREESTANDING BATH

- Colonial style acrylic bath with retro clawfoot support legs in chrome or black colour
- Lucite sanitary grade acrylic with fibreglass reinforced with polyester resins
- Durable scratch-resistant sanitary grade Lucite® acrylic material
- Clean and simple styling with easy-clean lines
- 1522 x 775mm size
- Simple installation
- Generous depth and 200L capacity





SELECT MKII 1500

J5152 | ACRYLIC INSET

1520mm (L) x 750mm (W) x 420mm (H)

- Rectangular form bath design
- Sanitary grade acrylic, fibreglass reinforced with polyester resin
- Integrated tiling lip on all edges
- Anti-slip surface on base
- Integrated self-supporting base board for easy installation
- Made of 3.2mm thick PMMA acrylic with 3.5mm of resin / fibreglass reinforcement
- Capacity 175L



SELECT MKII 1600

J5166 | ACRYLIC INSET

1660mm (L) x 750mm (W) x 235mm (H)

- Rectangular form bath design
- Sanitary grade acrylic, fibreglass reinforced with polyester resin
- Integrated tiling lip on all edges
- Integrated self-supporting base board for easy installation
- Made of 3.2mm thick PMMA acrylic with 3.5mm of resin / fibreglass reinforcement
- Capacity 210L

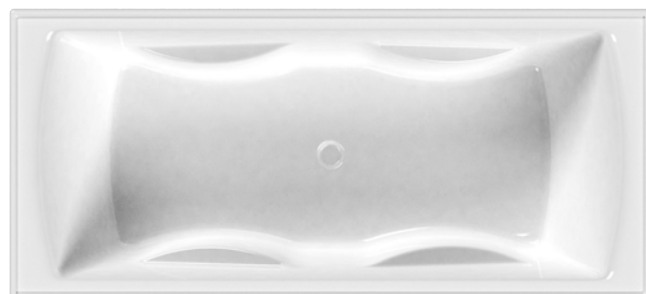

SELECT MKII 1800

J5180 | ACRYLIC INSET

1800mm (L) x 800mm (W) x 480mm (H)

- Rectangular form twin bath design
- Sanitary grade acrylic, fibreglass reinforced with polyester resin
- Integrated tiling lip on all edges
- Integrated self-supporting base board for easy installation
- Capacity 280L



ULTRA COMPACT BATH

J5050 | 1050

1050mm (L) x 700mm (W)

J5060 | 1200

1200mm (L) x 700mm (W)

- Quality European manufactured pressed steel bath
- Durable scratch resistant vitreous enamelled finish
- Modern styling with simple easy-clean lines
- Suitable for commercial or domestic installation
- 1500 x 700mm and 1200 x 700mm sizes to suit most installations
- Comfortable shape with generous depth
- Optional screw-adjustable legs available
- Perfect for smaller spaces
- Built-in seat for added comfort and safe seating for children



ATLANTICA 1700

J5040.42.44 | VITREOUS ENAMELLED STEEL

1700mm (L) x 800mm (W) x 410mm (H)

- Spacious anatomical bath design
- European quality pressed steel bath
- Durable scratch-resistant enamel
- Chrome hand grips
- Approved overflow kit & pop-up waste
- Capacity 210L



SHOWERSCREENS

Realising the visual importance of the basin in a bathroom, JohnsonSuisse offers a wide variety of choices to suit individual preferences for any bathroom aesthetic. From simple and classic styles to the more unique and contemporary, all JohnsonSuisse basins uphold the standard of quality and style.



All the JohnsonSuisse shower screens have been pre - treated with Enduroshield, a hydrophobic coating that creates a non-stick barrier resistant to corrosion, etching, and staining.

FEATURES & BENEFITS

DESIGN

Tough, safety glass combined with quality running systems and sleek handle design make a bold statement in any bathroom.

DURABILITY

The shower enclosures are masterfully made with durability and safety in mind.

FLEXIBLE

A range of shower enclosure configurations promise perfect fit in the space you have designated for your shower.

ENDUROSHIELD

Pre-treated with Enduroshield, making it easy to clean

ANTI-SLIP TRAYS

Treated product to avoid slipping while in use.



THE DAINTREE SHOWER RANGE

Daintree shower systems are uniquely designed for the smaller bathroom, featuring two sliding doors; with entry from the front corner. The semi-frameless design adds a modern, elegant look.



DAINTREE SQUARE
SHOWER SCREEN

- Saves space with sliding doors
- Magnetic seals making it leak-proof
- Adjustment range allows for the perfect fit
- Pre-treated with Enduroshield, making it easy to clean
- Safety Glass

Shower base compatibility with the Daintree Square shower screen:

- Daintree p78
- Barossa p78



DAINTREE CURVED
SHOWER SCREEN

- Saves space with sliding doors
- Magnetic seals making it leak-proof
- Adjustment range allows for the perfect fit
- Pre-treated with Enduroshield, making it easy to clean
- Safety Glass

* Please refer to page 80 for size and product code specifications

pictured
BAROSSA PIVOT SHOWER SCREEN | *page 83*
WITH BAROSSA POLYMARBLE BASE | *page 86*



Enduro
Shield

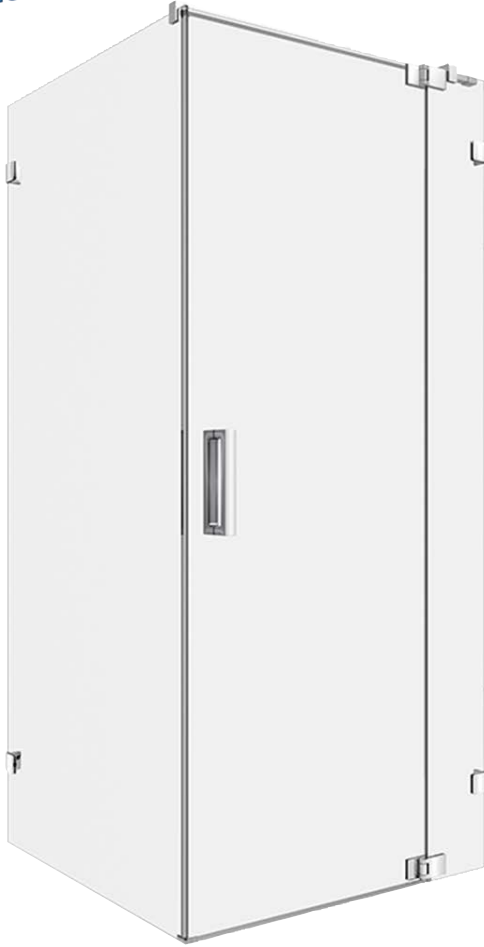

TIVOLI SHOWER SCREEN

The Tivoli shower screen features a revolutionary fully frameless design. The unique overlapping pivoting door and hinge design makes the Tivoli shower screen fully adjustable, and able to suit a large variety of shower bases and tiled floors. The Tivoli shower screen features 8mm toughened safety glass that has been pre-treated with Enduroshield, an easy-to-clean glass treatment – reducing glass cleaning by up to 90%.

- Pre-treated with Enduroshield, making it easy to clean
- Increased safety and durability with 8mm glass
- Adjustment range allows for the perfect fit
- Safety Glass

Shower base compatibility with the Tivoli shower screen:

- Daintree p78
- Barossa p78

* Please refer to page 80 for size and product code specifications

Enduro
Shield



BAROSSA SLIDER SHOWER SCREEN

With 8mm toughened glass, easy to clean Enduroshield™ and a new slim design, the Barossa Slider is the king of shower screens.

- Pre-treated with Enduroshield, making it easy to clean
- 8mm toughened glass for increased safety and durability
- Adjustment range allows for the perfect fit

Shower base compatibility with the Barossa Slider shower screen:

- Daintree p78
- Barossa p78

* Please refer to page 80 for size and product code specifications



THE BAROSSA SHOWER RANGE

Offering clean lines, a smooth finish and modern design features, the Barossa shower range is an investment in luxury. Easy to install and clean, the Barossa shower base combines practicality with style, making it perfect partner to the three Barossa shower screens, all equipped with toughened glass in a sleek design.



BAROSSA PIVOT SEMI-FRAMELESS SHOWER SCREEN

Utilising a sleek and minimal wall profile, the Barossa Pivot shower screen is easy to install. The Barossa Pivot shower screen features 8mm glass for increased safety and durability and suits the Daintree and Barossa shower bases and tiled floors.

- Toughened safety glass
- Adjustment range allows for the perfect fit

Shower base compatibility with the Barossa Pivot Semi - Frameless:

- Daintree p78
- Barossa p78



BAROSSA PIVOT FRAMELESS SHOWER SCREEN

Utilising a sleek and minimal wall profile, the Barossa Pivot shower screen is easy to install. The Barossa Pivot shower screen features 8mm glass for increased safety and durability and suits the Daintree and Barossa shower bases and tiled floors.

- Toughened safety glass
- Adjustment range allows for the perfect fit

Shower base compatibility with the Barossa Pivot Frameless:

- Daintree p78
- Barossa p78

* Please refer to page 80 for size and product code specifications

Enduro
Shield



Enduro
Shield



CORSICA SLIDER

SHOWER SCREEN

With its European frame design, smooth rollers and option of a matt black or chrome finish, the Corsica Slider shower screen makes a bold statement in any bathroom.

- Pre-treated with Enduroshield, making it easy to clean
- Toughened safety glass
- Fully reversible

Shower base compatibility with the Corsica Slider:

- Daintree p78
- Barossa p78

* Please refer to page 81 for size and product code specifications

Enduro
ShieldEnduro
Shield

CORSICA BI-FOLD

SHOWER SCREEN

Designed with the small bathroom in mind the Corsica Bi-Fold shower screen combines luxury and practicality. With its European inspired frame design, unique bi-fold system and 8mm toughened glass, this clever system is like no other.

- Pre-treated with Enduroshield, making it easy to clean
- Available in Black or Chrome
- Unique left hand or right hand bi-folding doors, perfect for small bathrooms
- Safety Glass

Shower base compatibility with the Corsica Bi-Fold:

- Daintree p78
- Barossa p78

* Please refer to page 80 for size and product code specifications



DAINTREE POLYMARBLE

SHOWER BASE

The Daintree Polymarble shower base is self-supporting for easy installation and features extra protection against leaks with built-in lips on all four sides.

- No grout and no joins, making it easy to clean
- Self-supporting for easy installation
- Solid, hardwearing material

Shower screen compatibility with the Daintree Polymarble:

- | | |
|--------------------------|------|
| • Daintree | p71 |
| • Barossa Slider | p73 |
| • Barossa Semi-Frameless | p75 |
| • Barossa Frameless | p75 |
| • Corsica Slider | p 76 |
| • Corsica Bi-Fold | p 77 |
| • Tivoli Frameless | p 73 |

* Please refer to page 81 for size and product code specifications



BAROSSA POLYMARBLE

SHOWER BASE

The Barossa Polymarble shower base is a modern, low-profile, self-supporting shower base featuring a stylish stainless steel channel grate and extra protection against leaks, with built-in lips on all four sides.

- No grout and no joins, making it easy to clean
- Self-supporting for easy installation
- Solid, hardwearing material

Shower screen compatibility with the Barossa Polymarble:

- | | |
|--------------------------|------|
| • Daintree | p71 |
| • Barossa Slider | p73 |
| • Barossa Semi-Frameless | p75 |
| • Barossa Frameless | p75 |
| • Corsica Slider | p 76 |
| • Corsica Bi-Fold | p 77 |
| • Tivoli Frameless | p 73 |

* Please refer to page 81 for size and product code specifications

EVO POLYMARBLE

SHOWER BASE

Eliminating the need for a mortar bed, the Evo Polymarble shower base is self supporting for easy installation, and comes with an anti-skid surface and built-in lips.

- No grout, no joins, easy to clean
- Self-supporting for easy installation
- Solid, hardwearing material

* Please refer to page 81 for size and product code specifications

**EVO POLYMARBLE CORNER**

SHOWER BASE

Eliminating the need for a mortar bed, the Evo Polymarble shower base is self supporting for easy installation, and comes with an anti-skid surface and built-in lips.

- No grout, no joins, easy to clean
- Self-supporting for easy installation
- Solid, hardwearing material

* Please refer to page 81 for size and product code specifications

**EVO POLYMARBLE CURVED**

SHOWER BASE

Eliminating the need for a mortar bed, the Evo Polymarble shower base is self supporting for easy installation, and comes with an anti-skid surface and built-in lips.

- No grout, no joins, easy to clean
- Self-supporting for easy installation
- Solid, hardwearing material

Shower screen compatibility with the Evo Polymarble Curved:

- Daintree Curved p73

* Please refer to page 81 for size and product code specifications



SHOWERS

SIZE & PRODUCT CODE SPECIFICATIONS

Daintree Curved shower screen

Daintree Curved shower screen	914 x 914 Chrome (actual size 855x880)	SSDA89CHCLP
	1000 x 1000 - Chrome (actual size 950x975)	SSDA99CHCLP

Barossa Slider Shower Screen

Front Panel Set	1200 - Chrome Alcove (actual size 1155 - 1175) Return (actual size 1170 - 1195)	SSBA34CHCLS
	1500 - Chrome Alcove (actual size 1435 - 1455) Return (actual size 1450 - 1475)	SSBA37CHCLS
Return Panel Set	900 - Chrome (actual size 860 - 885)	SSBA26CHCLR

Barossa Pivot Semi-Frameless Shower Screen

Front Panel Set	900 (actual size 860 - 885)	KSSPV26CHP
	1000 (actual size 960 - 985)	KSSPV40CHP
	1220 (actual size 1180 - 1205)	KSSPV34CHP
Return Panel Set	900 (actual size 860 - 885)	SSPV26CHR
	1000 (actual size 960 - 985)	SSPV40CHR

Barossa Pivot Frameless Shower Screen

Front Panel Set	900 (actual size 860)	KSSPP26CHP
	1000 (actual size 960)	KSSPP40CHP
	1220 (actual size 1180)	KSSPP34CHP
Return Panel Set	900 (actual size 860)	SSPP26CHR
	1000 (actual size 960)	SSPP40CHR

Tivoli Shower Screen

Door Panel Set	900 (actual size 860 - 890)	SSD326CHP
	1000 (actual size 960 - 990)	SSD340CHP
	1220 (actual size 1180 - 1210)	SSD334CHP
Return Panel Set	900 (actual size 860)	SSD326CHR
	1000 (actual size 960)	SSD340CHR

Corsica Slider Shower Screen

Front Panel Set	1220 - Chrome (actual size 1180 - 1225)	SSD534CHS
	1220 - Black (actual size 1180 - 1225)	SSD534BLS
	1500 - Chrome (actual size 1460 - 1505)	SSD537CHS
	1500 - Black (actual size 1460 - 1505)	SSD537BLS

Return Panel Set	900 - Chrome (actual size 860 - 905)	SSD526CHR
	900 - Black (actual size 860 - 905)	SSD526BLR
	1000 - Chrome (actual size 960 - 1005)	SSD540CHR
	1000 - Black (actual size 960 - 1005)	SSD540BLR

Corsica Bi-Fold Shower Screen

RH Door Set	900 - Chrome (actual size 860 - 905)	SSD526RCHB
	900 - Black (actual size 860 - 905)	SSD526RBLB
	1000 - Chrome (actual size 960 - 1005)	SSD540RCHB
	1000 - Black (actual size 960 - 1005)	SSD540RBLB

LH Door Set	900 - Chrome (actual size 860 - 905)	SSD526LCHB
	900 - Black (actual size 860 - 905)	SSD526LBLB
	1000 - Chrome (actual size 960 - 1005)	SSD540LCHB
	1000 - Black (actual size 960 - 1005)	SSD540LBLB

Return Panel Set	900 - Chrome (actual size 860 - 890)	SSD526CHR
	900 - Black (actual size 860 - 890)	SSD526BLR
	1000 - Chrome (actual size 960 - 990)	SSD540CHR
	1000 - Black (actual size 960 - 990)	SSD540BLR

Daintree Polymarble Shower Base

Square Rear Outlet	820 x 820 - White	SBD16CW
	900 x 900 - White	SBD26CW
	1000 x 1000 - White	SBD40CW
Rectangle Rear Outlet	1220 x 900 - White	SBD34CW

Barossa Polymarble Shower Base

Square Rear Outlet	900 x 900 - White	KSBB26CW
	1000 x 1000 - White	KSBB40CW
Rectangle Rear Outlet	1220 x 900 - White	KSBB34CW
	1500 x 900 - White	KSBB37CW

Evo Polymarble Shower Base

Square Rear Outlet	900 x 900 - White	EV26CW
	900 x 900 - White LH Ret.	EV2LCW
	900 x 900 - White RH Ret.	EV2RCW
	1000 x 1000 - White	EV40CW
	1000 x 1000 - White LH Ret.	EV4LCW
	1000 x 1000 - White RH Ret.	EV4RCW
Rectangle Rear Outlet	900 x 1220 - White	EV33CW
	1220 x 900 - White	EV34CW
	1220 x 900 - White LH Ret.	EV3LCW
	1220 x 900 - White RH Ret.	EV3RCW
	1500 x 900 - White	EV37CW

Evo Polymarble Corner Shower Base

Corner Rear Outlet	914 x 914 - White	EV39CW
	1000 x 1000 - White	EV29CW

Evo Polymarble Curved Shower Base

Curved Rear Outlet	914 x 914 - White	EV89CW
	1000 x 1000 - White	EV99CW

PRODUCT WARRANTY

GENERAL WARRANTY TERMS

Johnson Suisse is a brand owned by Bathroom Products Australia PL (hereafter referred to as BPA).

BPA is proud of the quality of the products that we offer over our different brands and full after-sales service is offered, should this be necessary.

In Australia, consumers are protected from the consequences of faulty or defective products by the Australian Competition and Consumer Act. Products must be fit for purpose and free from material and manufacturing defects.

BPA offers warranty terms that in many cases exceed the basic requirements, and different product types have different warranty periods and conditions. Warranty applies from the date of purchase (not installation), or for new buildings, from the date of handover.

This guide provides a reference as to what is covered by warranty and for how long. This first general terms section details the various warranty periods and the second section details the required conditions.

Note: Some BPA products may have a warranty period that differs based on whether they are used for Residential or Commercial purposes. Where terms and conditions for Commercial use are different to these of Residential use, they have been specifically detailed.

Commercial use includes all use types other than for normal domestic residential purposes.

BPA Reserves the right to make changes to its products at any time without prior notification.

Any part or product not specifically listed has a 1 year warranty period.

Explanation of terms:

Parts and labor - this is the warranty period during which the cost of removal and re-installation of a replacement product, should that be required, is covered.

Product replacement - this is the warranty period during which an equivalent replacement product will be supplied (note that this will not include installation - see below).

* Residential use

** Commercial Use

Showers

Polymarble Shower Base	15 years <i>product replacement</i>
Base	1 year <i>parts and labour</i>
Shower Screens	7 years <i>product replacement</i> 1 year <i>parts and labour</i>

Baths

Acrylic Baths	10 years <i>product replacement</i> 1 year <i>parts and labour</i>
Steel Baths	10 years <i>product replacement</i> 1 year <i>parts and labour</i>
Bath Components	1 year <i>parts and labour</i>

Sanitary ware

Toilet Suites & Urinals (Vitreous china items)	10 years <i>product replacement</i> 1 year <i>parts and labour</i>
Toilet Seats	1 year <i>parts and labour</i>
Vitreous China Basins	10 years <i>product replacement</i> 1 year <i>parts and labour</i>
Plastic & Inwall Cisterns	10 years <i>product replacement</i> 1 year <i>parts and labour</i>
Cistern Valves	3 years <i>product replacement</i>

Tapware & Bathroom Accessories

Tapware	15 years <i>ceramic disc cartridge product replacement</i> 7 years <i>product replacement</i> 1 year <i>parts and labour</i>
Tapware Finish	1 year <i>parts and labour</i>
Bathroom Accessories	10 years <i>product replacement*</i> 1 year <i>product replacement**</i>

Vanity Cabinets

Vitreous China Basin	10 years <i>product replacement</i> 1 year <i>parts and labour</i>
Cabinet	3 years <i>product replacement</i> 1 year <i>parts and labour</i>
Components	1 year <i>product replacement</i>

Nofer Hand Dryers

V-Jet	7 years <i>product replacement</i> 1 year <i>parts and labour</i>
Windflow & Fuga	5 years <i>product replacement</i> 1 year <i>parts and labour</i>

Commercial Products

Grab Rails, Back Rest and Shower Seat	5 years <i>product replacement</i>
Timer Trap	1 year <i>product replacement</i>
Electronic Tapware and Electronic Flush-Valves	2 years <i>product replacement</i>

WARRANTY CONDITIONS

Product Warranty is provided by: BPA Pty Ltd (ABN: 87 079 297 617)

PO Box 728 Botany,
Sydney, NSW, Australia. 1455.
T : 1300 717 717
F : 1300 746 480
E : bpa.warranty@johnsonsuisse.com.au

Product Warranty

The benefits given by the warranty set out in this document are in addition to any other rights and remedies you may have under a law in relation to the goods to which the warranty relates. Our goods come with guarantees that cannot be excluded under Australian Consumer Law. You are entitled to a replacement or refund for a major failure and compensation for any other reasonably foreseeable loss or damage. You are also entitled to have the goods repaired or replaced if the goods fail to be of acceptable quality and the failure does not amount to a major failure. The periods of warranty and terms of cover (i.e. product replacement or parts and labour only) are detailed below. Warranty applies from date of purchase, not from date of installation.

Warranty Claims

To make a claim under this warranty you must contact either the Merchant from which the goods were purchased or BPA directly by telephone, fax or email as set out above, with the following information:

- Details of the product type and product code
- A brief description of the product fault (with photographs of the fault)
- Proof of purchase of the goods including the date of purchase and where the goods have been installed
- Details of the licensed plumber who installed the goods.
- Your contact details and Handover documentation (if relevant)

BPA will then contact you within 7 days of first being advised of the claim by you or by the merchant (as the case may be) and depending on the circumstances arrange to either (a) replace the goods (b) repair the goods (c) replace and install new goods (d) request more information (e) reject the claim.

Where the goods claimed have not been installed, you must return the goods at your expense to either their point of purchase, or your nearest BPA distribution centre for evaluation. If the claim is then accepted, BPA will refund the freight cost to you when you give BPA proof of payment of the freight cost and the amount paid.

Water Damage

Some claims may include a claim for rectification of water damage to surrounding areas as a result of leaking from a product. Such claims will require a site-call by a BPA representative who will evaluate the claim. A further inspection by an insurance representative may also be required before a claim can be determined.

Warranty Conditions

BPA will not accept claims against this warranty where the following conditions are found to exist:

- Plumbing installations have not been carried out by a licensed plumber.
- Installations that are not in compliance with the Australian Plumbing Code (AS3500) and ABCB Guidelines.
- The goods have been installed by a licensed plumber but not correctly installed.
- The goods have been installed correctly by a licensed plumber, but subsequent repairs, modifications and/or adjustments to the goods after installation have not been carried out by a licensed plumber.
- Claims against faulty cistern valves and seals will be rejected where after-market sanitising additives have been introduced into the cistern tank rather than the toilet bowl.

- Claims for visual defects to product surfaces may be rejected where harsh cleaning or scouring products have been used (rather than mild household detergent and soft, non-abrasive cloths).
- Claims against vitreous china product faulty dimensions or glazing imperfections that are permitted under AS1976 - Vitreous China used in Sanitary Applications. It is permitted that vitreous china products will vary up to ± 3 mm on any surface and be acceptable due to the unique conditions of the product's manufacturing process.
- Claims where proof of purchase is not provided.

Warranty Limitations

To the extent permitted under Australian Consumer Law, BPA's responsibility is limited in the following circumstances:

- BPA is not responsible for any lack of operation or performance of goods (or loss or damage) where the goods have been subject to misuse, negligence, accident
- BPA is not responsible where goods are used or adapted for a purpose for which they were not designed.
- BPA is not responsible for any lack of operation or performance of goods (or loss or damage) where the goods are combined or integrated with other goods not supplied by BPA.
- It is the responsibility of the purchaser and/or installer, before installation, to ensure the goods are correct and free from obvious visible faults or defects.
- BPA is not responsible for labour and rectification costs incurred in the above circumstances.
- Breakage of any Glass part is not covered by warranty. Glass parts not reported broken upon receipt of goods, will not be replaced.

Except as expressly stated, and to the extent permitted by law, this warranty does not include any right to be reimbursed or compensated for physical or financial injury, loss, damage, expense, time or inconvenience (whether direct or indirect) or special or consequential losses arising out of the occurrence of a defect in the parts or products or caused by use or installation of the products or damages caused by acts of nature.

Site Calls and Technician Visits

Where BPA has arranged a site-call, and a claim is rejected following inspection (often in the case of unlicensed or incorrect installation), the consumer will be charged a call-out fee of \$120, payable to BPA.

In a case where BPA had arranged a repair or replacement, based on information received from a customer or merchant, and it was later found that BPA is not liable for the fault as identified on site, BPA will be entitled to recover any costs directly from the customer. BPA reserves the right to charge a service fee, to be payable by the warranty claimant. It is the responsibility of the warranty claimant to ensure that installed products are easily accessible for BPA to carry out warranty service. BPA will not be responsible for any costs where adequate access to products is not provided.

Warranties only apply to the original owner and are non-transferable.

For hygiene reasons, Toilet Seats cannot be returned once the packaging had been opened.

www.johnsonsuisse.com.au



JohnsonSuisse

Bathroom Solutions

2/97 Banksia Street, Botany NSW 2019 | T 1300 717 717 | F 1300 746 480 | www.johnsonsuisse.com.au

BATHROOM PRODUCTS AUSTRALIA PTY LTD ABN 87 079 297 617

SHOWROOM: 31 Koornang Road, Scoresby VIC 3179 Australia | T 1300 717 717 | F 1300 746 480

SYDNEY SHOWROOM: 2/97 Banksia St. Botany Sydney NSW 2019 Australia

Material and design specifications subject to change without notice.

Product colour reproduction is as near to actual product colour as production methods allow.

This brochure relates to Australian products only and some product, design or specifications may differ in other countries.